

HOW TO BUILD A TWO-VALVE PORTABLE RECEIVER

MODERN WIRELESS

1 1/2
MONTHLY



Vol. VI. No. 3.

Edited by
JOHN SCOTT-TAGGART
F.Inst.P., A.M.I.E.E.

AUGUST, 1926.

*In this
Issue*

THE "HOLIDAY TWO"

By

JOHN UNDERDOWN



LOOK

Grid with two supports

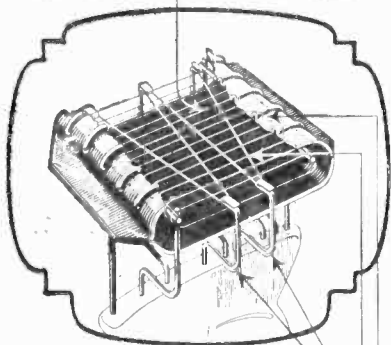

5 resilient filament supports keeping filament in permanent alignment.

Filament two complete loops.

Anode (with two supports) cut away to show filament and grid.

at this P.M. Filament and you will understand why P.M. Valves are the best value on the market.

THESE

seven P.M. advantages reduce your maintenance costs and give you better results--

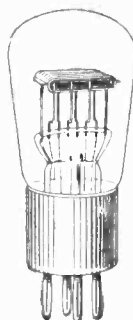

- 1 **GREATER EMISSION SERVICE.** P.M. Filaments have up to 5½ times greater emission surface than ordinary filaments ensuring a much wider range of power for economical operation; in fact, these new filaments are so conservatively rated that they give ample results at lower voltages than marked and will stand up to a reasonable overload.
- 2 **LONGER VALVE LIFE.** The special alloy of rare metals that forms the heavy covering of P.M. Filaments is prepared by a patented process that secures a copious flow of electrons and the operating temperature is so low that this precious alloy cannot be discharged, a definite proof of long useful life.
- 3 **UNBREAKABLE FILAMENT.** P.M. Filaments are longer than ordinary filaments, and retain their ductility even after 1,000 hours life, so that it is possible to tie them in a knot. At no time does the low operating temperature cause sag, and these filaments are specially set round the five strong resilient hooks so that they are free from tension and cannot be broken except by the very roughest handling.
- 4 **NO VISIBLE GLOW.** The extreme economy in heat of P.M. Filaments can be judged by the fact that no sign of glow can be discerned during operation.
- 5 **REDUCED CURRENT CONSUMPTION.** P.M. Filaments only require one-tenth ampere filament current, giving up to seven times the life of each accumulator charge, a reduction to one-seventh in your cost of accumulator maintenance.
- 6 **NO MICROPHONIC NOISES.** The unique method of mounting the filament within the field of the grid and anode, so that the filament lies without tension or sag in its correct position, and all the electrons are utilised and controlled, completely eliminates all microphonic noises, leaving an effective background of silence to emphasise faithful reception.
- 7 **MAJESTIC VOLUME.** Every P.M. Valve is a master valve in its own class designed to give you

It is the filament that counts and this is what you pay for.

For 4-volt accumulator or
3 dry cells

THE P.M.3. (General Purpose)

0.1 amp. 16/6

THE P.M.4 (Power) 0.1 amp. 22/6

For 6-volt accumulator or
4 dry cells

THE P.M.5 (General Purpose)

0.1 amp. 22/6

THE P.M.6 (Power) 0.1 amp. 22/6

For 2-volt accumulator

THE P.M.1 H.F. 0.1 amp. 15/6

THE P.M.1 L.F. 0.1 amp. 15/6

THE P.M.2 (Power) 0.15 amp. 18/6

These prices do not apply in Irish Free State



Perfect Radio Reception

ASK YOUR DEALER FOR THE VALVES
WITH THE P.M. FILAMENT

Mullard

THE MASTER VALVE

ADVT. THE MULLARD WIRELESS SERVICE CO., LTD., BALHAM, LONDON, S.W.12.

CONTENTS

VOL. VI. MODERN WIRELESS No. 3

	PAGE		PAGE
The "Quality Five"	195	Further Developments at Elstree	238
By JOHN W. BARBER.		Regular Programmes from Continental Broad-	
In Passing	201	cast Stations	239
The "All-Europe" Superheterodyne	203	By Capt. L. F. PUGGIE, B.Sc., F.R.Ae.S.,	
By PERCY W. HARRIS, M.I.R.E.		F.R.Met.S.	
Reminiscences of a Pre-Broadcast Listener	207	A Novel "Change-Over" Crystal Set	241
The "Holiday Two"	210	By D. J. S. HART, B.Sc.	
By JOHN UNDERDOWN.		Judging for Themselves	244
Improving Your Aerial	215	Off the Beaten Track	246
By G. P. KENDALL, B.Sc.		How to Use the Screened Coil	250
From My Notebook	218	By J. H. REYNER, B.Sc., A.M.I.E.E.	
By H. J. BARTON-CHAPPEL, Wh. Sch., B.Sc.		"What on Earth"	254
(Hons.), etc.		By JOHN UNDERDOWN.	
Neutralising Facts and Fallacies	220	Simplicity Whys and Wherefores	260
By E. M. MASON.		By PERCY W. HARRIS, M.I.R.E.	
Phenomenal Success of "Elstree Six"	222	Vital Problems in Superheterodyne Design	264
The "Screened-Coil Three"	225	By C. P. ALINSON, A.M.I.R.E.	
By J. H. REYNER, B.Sc. (Hons.), A.M.I.E.E.		An "All-Wave" Absorption Wave-Meter	268
Elstree's Fame Extends	230	By G. P. KENDALL, B.Sc.	
Short-Wave Transmission Under Difficulties	231	Are We on the Wrong Track?	271
By A. V. D. HORT, B.A. (5HU).		By A. W. MEREDITH.	
Ballasting Resistors for Filament Control	235	Tested by Ourselves	274
By THE STAFF OF THE RADIO PRESS LABORA-		"Does All You Claim"	285
TORIES.			

Edited by JOHN SCOTT-TAGGART, F.Inst.P., A.M.I.E.E.

RADIO PRESS LTD., BUSH HOUSE, STRAND, LONDON, W.C.2. Telephone: City 9911

Nothing contained herein is to be regarded as permission or encouragement to infringe any patent rights.

Bowyer-Lowe JACKS

- another series of Tested and Proved Components by Bowyer-Lowe

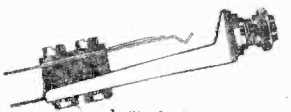

1. Single circuit open
List No. 231 ... 2/2

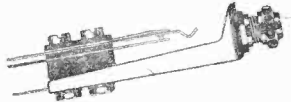

2. Single circuit closed
List No. 232 ... 2/7

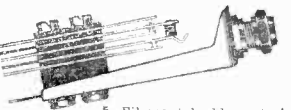

6. Filament double control
List No. 235 ... 3/3

MADE specially for wireless use, the new Bowyer-Lowe Jack gives immense superiority over that adapted from telephone uses. In addition to girder construction for stability, the fan-tailed contacts facilitate soldering. Insulation of the finest ebonite and silver contacts are a few of the improvements which emphasise both to expert and amateur the necessity of specifying Bowyer-Lowe Guaranteed Jacks.

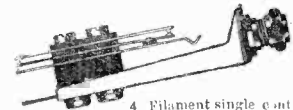

4. Filament single control
List No. 234 ... 2/9



3. Double Circuit
List No. 233 ... 3/-



Perspective view showing fan-tailed contacts



ANNOUNCEMENT BY THE BOWYER-LOWE CO. LTD. LETCHWORTH, HERTS

Tell the Advertiser you saw it in "MODERN WIRELESS."



NEW TRIUMPHS OF VALVE RESEARCH SEASON 1926-1927

CLEARTRON Research Departments, both here and in America, have been assiduously at work ever since the Birmingham factory opened, to prepare for the coming season a new and startlingly improved series of CLEARTRON VALVES of all types.

As a result, the present range of CLEARTRON VALVES will be superseded by a new 1926/1927 series embodying these discoveries. *Electronic emission is increased, the vacuum heightened and the life of the valve lengthened.* After exhaustive tests new types of filaments have been adopted and the construction rendered shock-proof. Microphonic noises have been reduced to an absolute minimum.

The new series is expected to be on sale by August 15th, when full technical details will be available in CLEARTRON'S New Season Price List. Meanwhile the 1925 range can still be obtained at 12/6 and 15/- so long as the present supplies last.

The new range of CLEARTRON VALVES are sold, of course, with
CLEARTRON'S IRONCLAD GUARANTEE

Full technical data of all types obtainable from your dealer or from

CLEARTRON RADIO LIMITED

ONE CHARING CROSS, LONDON, S.W.1 (Works: BIRMINGHAM)

Telephone: Rejent 2231/2.

Telegrams: "Cleartron, Westrand, London."



CT/53

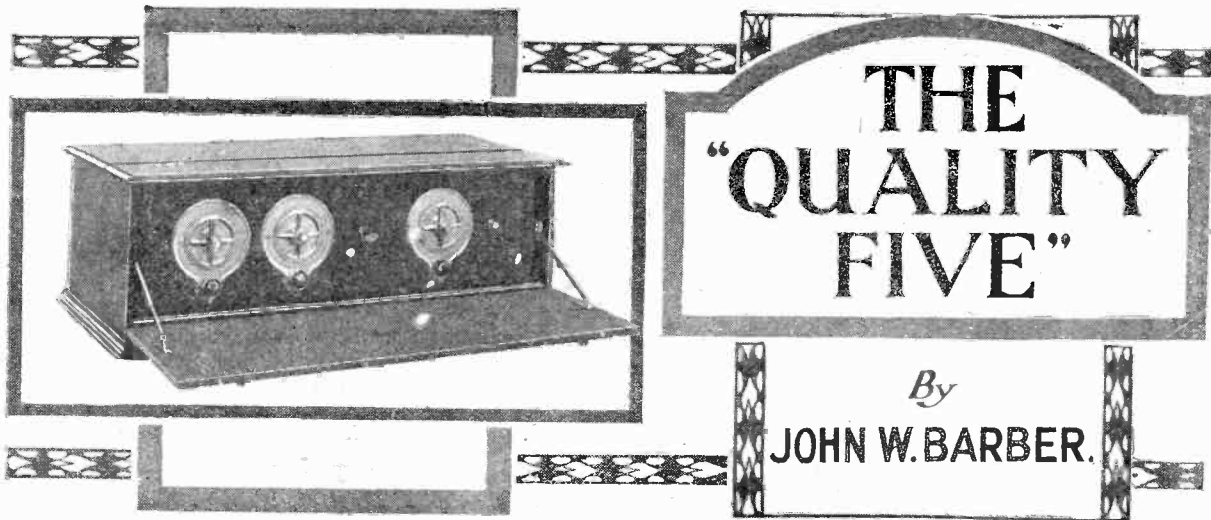

This Five-valve Receiver employs one stage of neutralised H.F. amplification and three stages of resistance-capacity low-frequency magnification. It is designed for pure reproduction, and when desired the local station can be cut out by means of a wave-trap incorporated in the set.

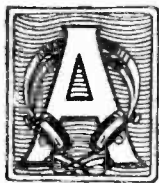

All music lovers will agree that, unless music is absolutely natural and perfectly free from harshness and unnatural distortion, it is not worth listening to, and those interested in the musical side of broadcasting

stations many leagues away, but unless he has a set which can bring in these stations without recourse to excessive reaction, his musical friends will not be greatly impressed.

Reasonable Selectivity

When attempting to receive distant stations, especially in close proximity to the local station, there

tion, which necessitates the use of several tuning condensers, the problem is somewhat large.

The use of several tuned stages may necessitate the employment of a wavemeter for tuning purposes, and even should this not be necessary, one usually wants more than the allotted pair of hands to turn the necessary dials.

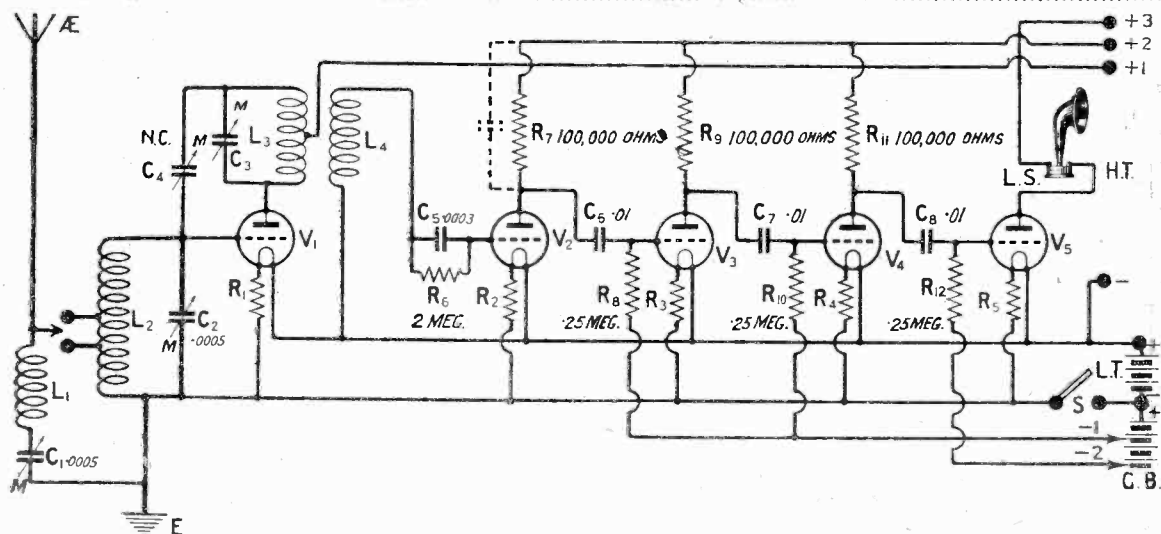

Fig. 1.—In certain circumstances an improvement may be effected by connecting a small fixed condenser of about .0003 across R7 as shown dotted. This, however, was not found necessary in the actual receiver described.

will admit that, unless a station is received with purity, then one may as well switch off. Of course, there is a great deal to fascinate the enthusiast in hunting round for

is the additional problem of eliminating the transmission from the nearby station, and unless one is prepared to employ several stages of tuned radio-frequency amplifica-

A Wave Trap

Alternatively some form of wave-trap may be employed, and if this course is adopted the circuit should

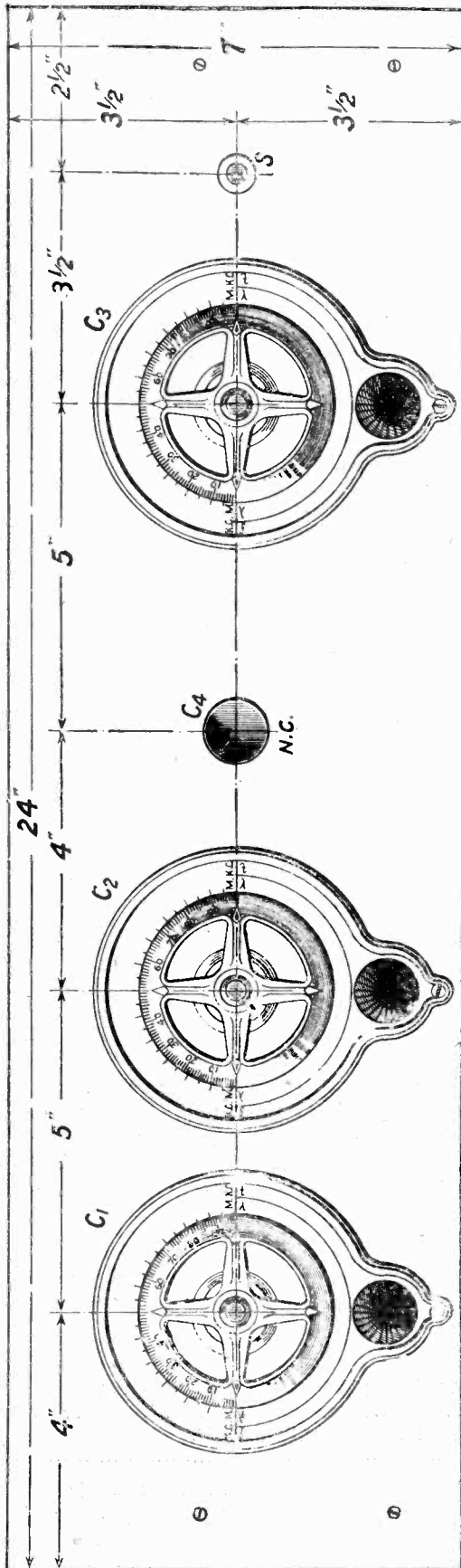

Fig. 2.—Constructors wishing to obtain a full-sized drilling diagram should ask for Blue Print No. 170a (free).

The "QUALITY FIVE"—Contd.

preferably be built into the receiver, on the score of compactness. This principle has been adopted in the present instance.

The receiver described in this article has been designed to give the purest speech and music, so that it is suitable for use as a "family" receiver. The left hand dial is that controlling the wave-trap condenser, which can be set for the elimination of the local station, the tuning being carried out on the remaining two condensers, which are for tuning the grid and anode circuit respectively. Thus the set can be left tuned to a station, and just turned on and off by means of the switch provided.

The Circuit

A consideration of the circuit diagram will show that there are, in all, five valves, the first being a high-frequency amplifier, followed by a detector, and three resistance-capacity coupled low-frequency amplifiers.

The trap employed is of the parallel acceptor type. The X coil, which, with its .0005 condenser C_2 forms the grid circuit of the high-frequency valve V_1 , is placed so as to be in the position of minimum coupling with the wavetrap coil L_1 , and it will be obvious that, in order to render the wavetrap inoperative, one can withdraw the coil L_1 from its socket, when the aerial circuit consists simply of an auto-coupled circuit. Of course, when receiving the local station, it is not necessary to remove the wavetrap coil, the condenser C_1 merely being rotated so that the wavetrap is not tuned to the particular frequency to be received.

The High-Frequency Valve

The anode of the high-frequency amplifier is tuned by means of the centre-tapped coil L_3 and condenser C_3 , the centre tapping being joined to the positive of the high tension battery. By this means, the ends of the circuit L_3, C_3 are always at opposite radio-frequency potential, hence we can neutralise the effect of the valve capacity by connecting a small condenser from the top end of the anode circuit to the grid of the high-frequency valve, and thus obtain stabilisation.

The Low-Frequency Side

In the anode circuit of the detector valve, as in the case of the two following valves, is a non-inductive wire-wound high resistance, of 100,000 ohms, the transfer to the next valve being effected in each case by means of a fixed mica condenser, of .01 capacity.

Fixed Resistors

The constancy of the modern valve is such that it is not necessary to adjust the filament temperature critically, and hence the need for filament resistances of the adjustable type is largely obviated, and one can use fixed resistances with safety. In the case of the present receiver, designed to work with valves of the DE5 class four ohm resistances are used, but figures suitable for other valves can be obtained from the makers.

The Components

The component parts used in the construction of this receiver are listed below, and in order to assist readers who may desire to make a set exactly following the lines of the present one, the names of the makers of the various parts are given. It must, however, be understood that other components of equal quality may be substituted,

CUTS OUT YOUR LOCAL STATION

provided that they will fit into the spaces provided. As far as the values are concerned, these should be adhered to, however, as any alteration may result in the receiver not functioning at its best, or may even, in extreme cases, prevent the set from giving any results at all.

One mahoganite panel, 24 ins. by

Four single coil mounts. (Beard and Fitch, Ltd.)

One combined .0003 condenser and 2 megohm leak. (Watmel Wireless Co.)

Three wire wound 100,000 ohm resistances, with bases. (Mullard Wireless Service, Ltd.)

Three .01 mica condensers. (Paragon Rubber Co., Ltd.)

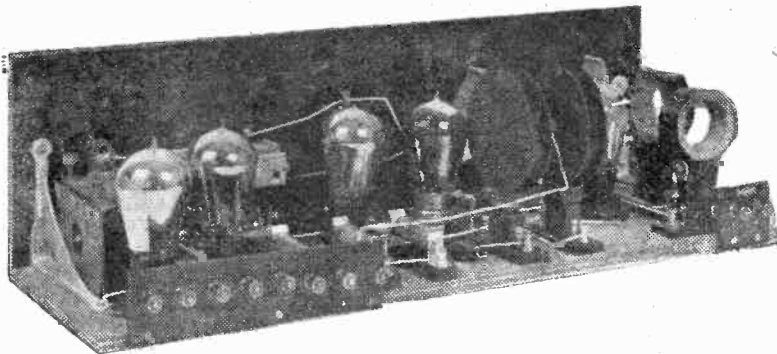

A wave trap is incorporated in the set itself and no difficulty should be found in cutting out the local station.

7 ins. by 3-16ths in. (American Hard Rubber Co., Ltd.)

Suitable cabinet, fall front type, with 8 in. baseboard. (Camco.)

One pair of brackets. (Camco.)

Five Lotus valveholders. (Garnett, Whiteley and Co., Ltd.)

Three Eureka straight line frequency variable condensers. (Portable Utilities.)

Three Microvern dials. (Igranic Electric Co., Ltd.)

One Vernier condenser. (Igranic Electric Co., Ltd.)

Five Cyldon "Temprytes" to suit valves, with bases. (Sydney S. Bird.)

Three Clip-in grid leaks, with bases. (L. McMichael, Ltd.)

One on-and-off switch. (Igranic Electric Co., Ltd.)

One terminal strip with 8 terminals.

One terminal strip with 2 terminals.

One 9-volt grid bias battery. (Siemens Bros. and Co., Ltd.)

One centre-tapped B coil. (Gambrell Bros., Ltd.)

One each Lissen X coils, Nos. 50 and 75. (Lissen, Ltd.)

Three Clix or H.T. battery plugs for grid-bias battery.

Glazite, wood screws, flex.

Radio Press panel transfers.

Constructional Details

The first step in the construction should be to drill the necessary holes in the panel, to take the three variable condensers, the neutralising condensers, and the switch, after which the panel and brackets and baseboard should be assembled, care being taken to set the brackets in sufficiently to clear the fillets on the side of the cabinet.

When this has been done, and the whole assembly will slide easily into and out of position in the case, the panel should be removed from the brackets, and set aside while the components are mounted up on the baseboard.

In this respect, if the components specified are used, the wiring diagram, which shows the layout, should be carefully followed in order that the valves may be able to ride quite freely in the sockets, without the risk of knocking against some other component. If you use other components, ascertain by trial that the DE5 type of valve will fit in easily before screwing down.

The Panel Components

Having mounted everything upon the baseboard, the panel components should be mounted, and the wiring commenced. Start by

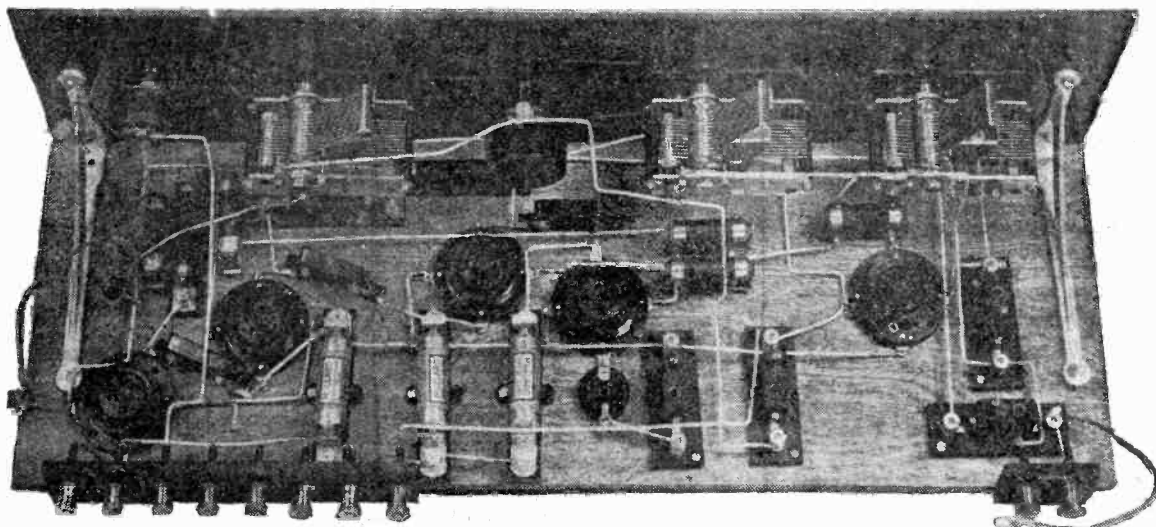

The switch seen on the left of the panel controls the filaments of all the valves.

THE "QUALITY FIVE" — (Continued)

carrying out all the necessary wiring on the baseboard before you reassemble the panel to it, as otherwise you may have difficulty in getting at some of the places where wires have to be soldered.

Care should be taken to ensure that the wiring is carried out exactly as shown especially in respect of the socket for coil L₂, which must be joined up as illustrated, on account of the fact that the Lissenagon X coil must be connected so that the tapplings come on the earth side. This is correct as shown, and the wiring to this socket should be carefully adhered to.

Wiring Up

Flexible leads are used from the grid leaks and L.T. negative to the grid-bias battery, while the wiring is so arranged that every terminal for external connection is at the

back of the set, thus rendering it possible to tune the set in, and to close up the front of the cabinet, without having to drill holes in the woodwork for loudspeaker leads, for example.

greatest selectivity when the lower number, or smaller tapping, is employed.

Attaching the Panel

Having completed the wiring up of the components upon the baseboard as far as is possible, the panel should be lightly attached to the brackets, and the necessary leads bent to shape, when they may be soldered to the correct places, the panel being removed if necessary to facilitate connections being soldered to the

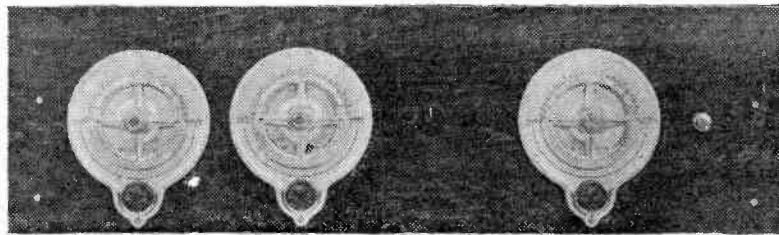

The special dials used render fine tuning a very simple matter.

The Tappings

Another flexible lead is employed to connect up from the aerial to the tapping on the Lissenagon X coil, so that each tapping in turn may be tried, in order to obtain the best signal strength or selectivity, the former being obtained when the tapping indicated by the higher number is in use, and the

soldering lugs on the condensers, for example. Finally, secure the panel to the brackets, and complete the wiring by fixing up the few remaining joints.

The grid battery is placed, as will be seen from the photographs, next to and inside the right-hand bracket, when the set is viewed from the front. The connection to

WIRING INSTRUCTIONS

Join one side of R10 to one side of R8 and then join to R8 a length of flex with wander plug for G.B.—1.

Join length of flex with wander plug for G.B.—2 to one side of R12.

Join one side of switch to one side of R5; same side of R5 to one side of R4; same side of R4 to one side of R3; same side of R3 to one side of R2; same side of R2 to one side of R1; same side of R1 to moving plates of C2; moving plates of C2 to moving plates of C1; moving plates of C1 to pin of holder for L2; and pin of holder for L2 to earth.

Join L.T. + to H.T.— and F+ of V5; F+ of V5 to F+ of V4; F+ of V4 to F+ of V3 and F+ of V2; F+ of V2 to pin of holder for L4; pin of holder for L4 to F+ of V1.

Join remaining side of R1 to F— of V1.

Join remaining side of R2 to F— of V2.

Join remaining side of R3 to F— of V3.

Join remaining side of R4 to F— of V4.

Join remaining side of R5 to F— of V5.

Join fixed plates of C3 to A of V1, thence to pin of holder for L3.

Join fixed plates of C4 to fixed plates of C2; fixed plates of C2 to socket of holder for L2; and socket of holder for L2 to G of V1.

Join fixed plates of C1 to pin of holder for L1.

Join moving plates of C3 to moving plates of C4, thence to socket of holder for L3.

Join remaining side of R8 to G of V3 and one side of C6.

Join other side of C6 to A of V2, and thence to one side of R7.

Join other side of R7 to one side of R9; same side of R9 to one side of R11 and to H.T. +2.

Join remaining side of R10 to G of V4 and one side of C7.

Join other side of C7 to remaining side of R9, thence to A of V3.

Join remaining side of R12 to G of V5 and one side of C8.

Join other side of C8 to A of V4 and remaining side of R11.

Join G of V2 to one side of R6 and C5.

Join other side of R6 and C5 to socket of holder for L4.

Join aerial to socket of holder for L1 and attach length of flex for tap on L2 to socket of holder for L1.

Join wire for connection to centre tap of L3 to H.T. +1.

Join H.T. +3 to LS+.

Join other LS terminal to A of V5.

Join L.T.— to remaining side of switch and to length of flex for G.B. +.

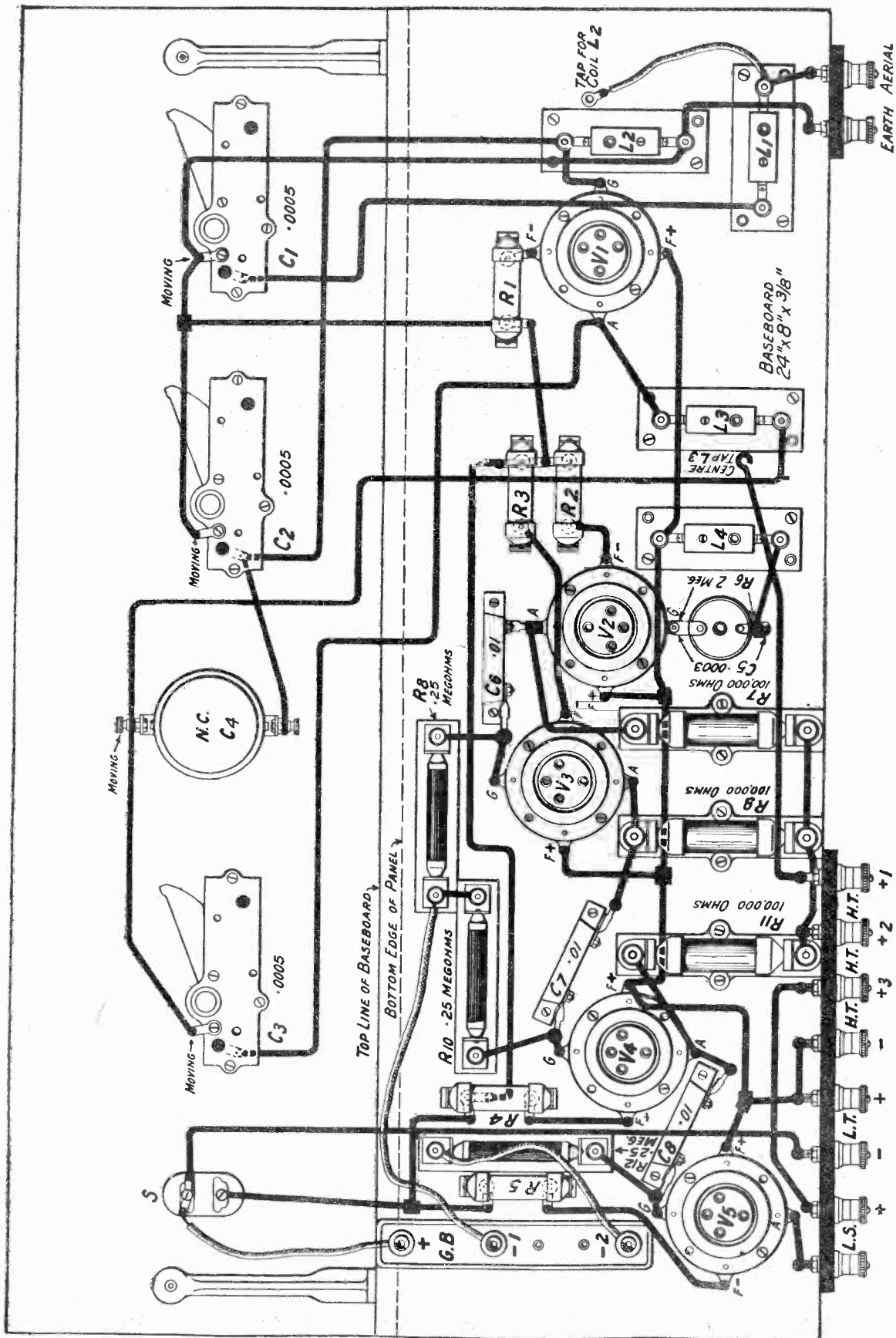

Fig. 3.—The flexible lead seen on the right connects the aerial to a suitable tap on the "X" coil. A full-sized blue print No. 170b, may be obtained free.

THE "QUALITY FIVE" — (Concluded)

the positive of this battery is made by means of a Clix plug on the end of a piece of flexible wire, which is secured at its other extremity to the filament switch, which, for the sake of simplicity in the wiring, is in the negative filament lead.

First Tests

The next thing to do is to insert the anode resistances into the clips on their bases, and to do likewise with the Temprytes and grid leaks. Now insert the valves, and join up the accumulator. Switch on, by pulling the switch knob out, and note that all valves are lighting correctly. If they are not, examine the leads to the accumulator. If one valve only is not alight, make certain that the Tempryte is making good contact with its

Coils

Insert a Lissenagon X coil in the L_2 socket, and join up the flexible lead to one of itsappings. Plug in the centre-tapped coil, and join up its centre tap to the lead to H.T.+. Insert a No. 75 or C coil in the L_4 socket, leaving the wavetrap coil socket empty for the moment, and the aerial and earth disconnected.

Neutralising

Now switch on, and set the middle and right hand condensers at their minimum setting. You will probably find now that the set is oscillating, and that this oscillation can be stopped by movement of the neutralising condenser. The

strength, and then slowly rotate the wavetrap condenser. The signals will be noticed to weaken quite suddenly, a point being found where they disappear entirely, and on either side of which they are heard, weak at first, but rapidly attaining full volume as the condenser is turned.

Valves

The set has been used with a D.E.5 valve for H.F., three D.E.5B valves, and a D.E.5 in the last stage, and gave excellent results with 120 volts on the resistance - coupled valves. Other valves may, however, be used with success, provided that they are suitably chosen for the various functions, for example,

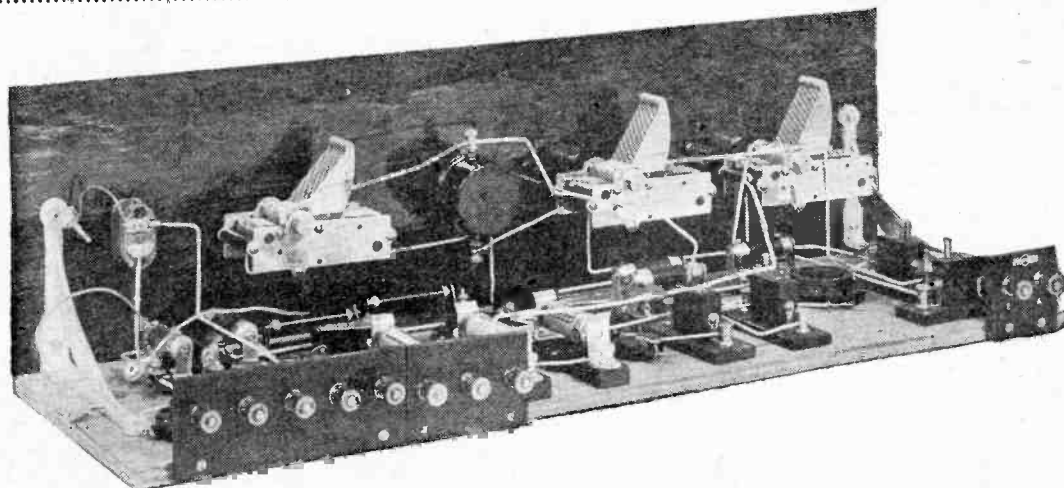

The receiver is designed to combine purity with selectivity. The neutralising arrangements ensure perfect stability.

clips. If all valves are lighting correctly, switch off and join the accumulator across the high-tension terminals, shorting the telephone terminals for the time being with a piece of wire. No valve should light up now, with the switch in either "on" or "off" positions, and if such is not found to be the case, an immediate investigation should be made, as if the high tension battery be connected up now, damage will result to one or more of the valves. If, however, no valve is seen to light during the second test, replace the accumulator leads on their correct terminals and join up the H.T. battery. Remove the shorting wire from the telephone terminals, and join up the 'phones or loudspeaker.

latter should be adjusted to stop oscillation, and the dials slowly rotated, slight readjustment being made upon the neutralising condenser if necessary to stop oscillation. When you can turn both dials over the whole of their scales without causing the set to break into oscillation, the circuit is properly neutralised.

The Aerial Test

The aerial and earth are now connected up, and a No. 75 or 100 coil inserted into the wavetrap socket. Leaving the wavetrap condenser (left hand) at minimum reading, carefully rotate the remaining two dials, when signals from the local station will soon be picked up. Tune these in to the best possible

an H.F. valve in the high-frequency stage, followed by three valves suitable for resistance - capacity coupling, with a power valve in the last socket.

Results

On a standard P.M.G. aerial, 40 ft. high, in S.E. London, the transmission from 2LO was extremely loud, while purity was excellent, the grid bias being adjusted to give the best results. With the wavetrap set, several other stations were received at good loudspeaker strength, and in the course of a short test the set gave every indication of liveliness, and appeared capable of bringing in the distant stations in a very satisfactory manner.



THERE is no doubt," remarked Professor Goop as we sat chatting some nights ago, "that the 'Elstree Six' is a really wonderful set. I am afraid I must admit, my friend, that for the moment the rival experts have stolen a march upon us." "But surely," I cried, "you are not going to be content to leave it at that. Let us at once design the 'Puddleton Seven' and re-establish our old lead. They have used double condensers; let us use triple condensers. Their set will receive every existing broadcasting station; let ours be so powerful that it will receive even those which do not exist. They have tapped both inductances and variable condensers in the centre; I have a much better idea than this." "And what is that?" queried my old friend. "Why," I said, "let us use a 200-volt high-tension battery and tap that in the centre. The advantage of doing this is obvious to the meanest intelligence. The battery lasts twice as long and, what is more, when one half conks

"A centre tapping," remarked the Professor dreamily.

We Begin

Without more ado we set about the experimental work which must always precede the design of a super set. We were a little puzzled at first to know what to do with our seven valves, for we agreed that nobody could need more than three high-frequency stages and two low frequency. Just then Puddleby came in and we co-opted him as a member of the board of research. Puddleby's solution of the difficulty was masterly. "If you want to be really original, why not have two rectifiers? One of them can function upon the anode bend system and the other upon the cumulative grid method. It is well known that the former gives greater selectivity and less

distortion whilst the latter is the more sensitive of the two. By incorporating both systems you naturally obtain a complete absence of distortion coupled with sensitiveness and selectivity." This seemed so excellent an idea that we decided to adopt

that are inclined to sensitiveness make their way to the other. In describing the high-frequency side of the set I am afraid that I shall have to be a little technical, but I trust that my readers will bear up.

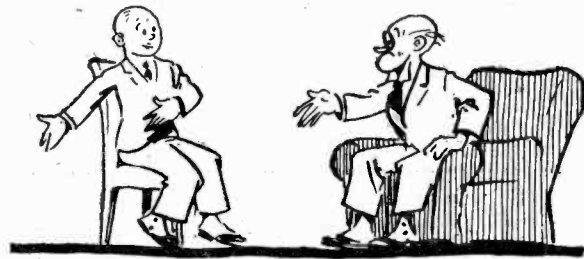

"A centre tapping," remarked the Professor.

The H.F. Side

The circuit may be described as a by-form of the well known Bonehead-Glump arrangement. One marked disadvantage of this circuit in its standard form is that oscillations are apt to be turned inside out owing to the occurrence of semi-paralytic metarhombistic effects coupled with pseudo-hysteresis and amorphotropic hombination, with marked traces of yellow sodium lines towards the middle of the filament spectrum. This is clearly a most undesirable feature since it leads inevitably to phlogistic dimembolitosis, known popularly as loud-speaker whooping-cough. As modified by Professor Goop and myself the circuit takes a hyperemphysoidal rather than a petanophthalmoidal form, and by conburbulating the grid circuits we have succeeded in producing complete stability combined with an entire absence of ululatory tendencies. This is accomplished quite simply by means of a process so familiar that I need scarcely bother to describe it, and in any case the actual details have for the moment slipped my memory.

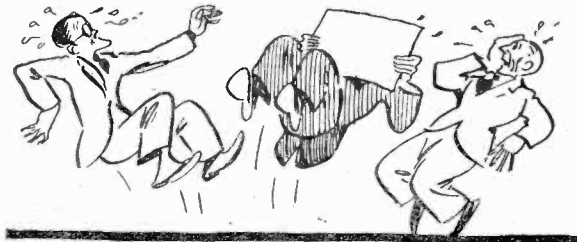

Mr. Hercy Parris, Mr. Bendall and Mr. Brayner fainted.

out you can fall back upon the other. The same principle could be applied to the filament battery by making use of a centre-tapped eight-volt accumulator. Let us gird up our loins, let us pull up our socks, let us up and smite them about the fifth waistcoat button."

it without further argument. In the "Puddleton Seven" therefore oscillations after undergoing three stages of high-frequency amplification are offered a choice of rectifiers. Those that desire to be selective pass into the anode bend circuit, whilst those

IN PASSING — (Concluded)

A Lucid Description

And now that you have the theory of the high-frequency side of the set quite clear in your mind you will have little or no difficulty in following the rest of the circuit diagram, which would be given herewith but for the fact that when it reached Bush House, Mr. Hercy Parris, Mr. Bendall and Mr. Brayner fainted at the sight of it, and could not be restored to consciousness until sympathetic friends

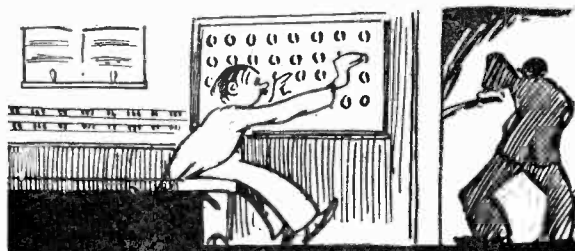

Give him plenty of knobs.

assured them that it had been destroyed. This just shows you the lengths to which professional jealousy will carry men who in the ordinary course of events are quite pleasant fellows, seldom drinking their bath water or devouring their own young. I am naturally a little handicapped in having no diagram on which to base my description; nevertheless being one of the bull-dog breed I shall carry on, asking the sympathetic reader to supply the diagram from his own fertile imagination. On second thoughts I think that he may also supply the description from the same source. This is perfectly easy once you have got the knack. The great thing is to get a good start. Something like this: L_1 the aerial coil is loosely coupled to the tuned circuit L_2C_1 , the inductance L_2 being a standard Crimic coil. C_1 is really C_2, C_3 and C_4 , being a triple condenser though all the sections are connected in parallel.

In place of the old-fashioned fixed resistors Professor Goop and I are introducing a novelty in the shape of a component called the rheostat. This is a neat little gadget consisting of a coil of resistance wire wound upon a former of almost-ebonite and lightly brushed by a moving arm which always comes loose at the critical moment. One great advantage of the rheostat is that it adds an extra

knob upon the panel for each valve behind it, and we would like to emphasise the fact that the "Puddle-ton Seven" is a receiving set with knobs on.

Quite a Mistake

A mistaken idea exists in certain quarters that the great wireless public is demanding sets with hardly any knobs upon their panels. If I know anything of the great wireless public, their desires are quite otherwise. When the real

expert visits one of his more humble brethren to put the latter's receiving set through its paces his first remark is always, "Naturally you would hardly expect fine tuning if you use fixed grid-leaks. Now you should just see what I can do with my receiver." The expert's own set, simplified, of course, to the utmost possible limit, seldom contains less than 43 knobs, and with it, if nothing goes wrong, he is generally able to obtain quite respectable reproduction of the local station. What is not realised in high places is that the man who operates a wireless set yearns and yearns to twiddle things. Whittle down his cherished knobs to two or three and he is like an organist with one keyboard or a Wimbledon tennis player with but a single racquet. Give him heaps of knobs, most of them serving no very useful purpose, and he will be perfectly happy, playing contentedly with his apparatus for hours on end.

We Construct

It took some little time to construct the "Puddle-ton Seven," owing to the great difficulty we had in obtaining the necessary components. For some reason or other there seems to be an idea among our fellow club members that the Professor and I have not lost the war-time habit of winning things. This is, of course, entirely unjust, and I must say that I was

not a little nettled when one or two fellows who were discussing the recent loss of half a dozen receiving sets and fifty valves from the Elstree Laboratories asked rather pointedly if I had not been in town on that evening. Others have also inquired in a rather offensive way whether it was not in anticipation of a visit from me that the "Elstree Six" was firmly fixed to a table by means of screws.*

Difficulties

However, in order to show you how thorny our path was I may say that there was quite a scene when Snaggsby, who had been away for a day or two called round at the Microfarads to see how we were progressing. Recognising his most cherished transformer, which the Professor was engaged in securing to the baseboard by means of ten-penny nails (having run temporarily out of screws) he turned exceedingly nasty.

Another difficulty that we experienced was that no room in the Professor's house was big enough to contain the "Puddle-ton Seven" if constructed in accordance with our designs. Luckily the General was away at the time and it occurred to us that his billiard room would be just the place. We were, in fact, able (rather ingeniously) to convert the table into the receiving set by turning it upon its side and using for our panel the slate bed, whose



A delightful surprise awaits him

insulating properties are excellent. The General is expected back next week and on his return a delightful surprise awaits him for we have kept the "Puddle-ton Seven" a dead secret.

"THE LISTENER-IN."

*It was. We thought it wise to take no chances though Mr. Listener explained that the cricket bag which he was carrying on arrival at the laboratories contained a specially made gridleak that he was taking home for Professor Goop.—ED.

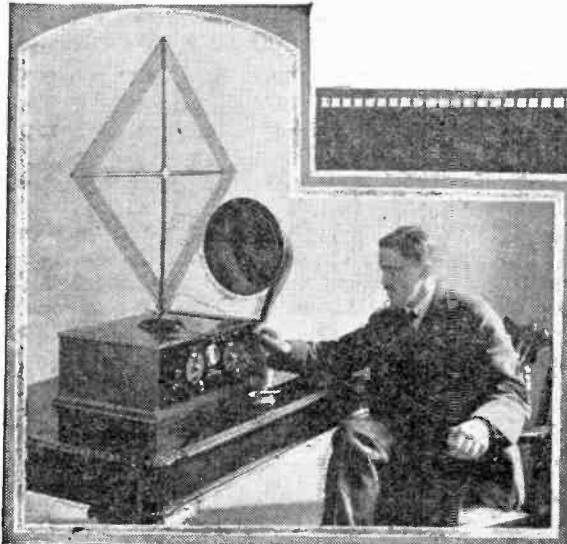

The
“ALL-EUROPE”
SUPERHETERODYNE
BY
Percy W. Harris,
 M.I.R.E.

In this, the continuation of his article describing the construction of an Eight-valve Superheterodyne Receiver in the last issue, Mr. Percy W. Harris gives some useful hints on the operation of the set. Full details are also given of how to use various Superheterodyne Intermediate Transformers with but little alteration to the layout.

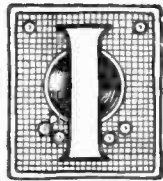

IN the last issue I gave particulars of the construction of an eight-valve Superheterodyne Receiver, and it will be remem-

bered that we reached the point where the reader could finish the constructional work of the set. The operation of the superheterodyne receiver, to those who have not previously handled such instruments, is rather peculiar, and a little patience is needed before the “hang” of the instrument is obtained. In any case the following procedure should be adopted before any serious searching is undertaken.

and join up the low-tension accumulator. Pull out the on-and-off switch to the “on” position and turn the voltmeter switch to the left. It should immediately show the voltage of your accumulator and, if this is correct,

take one of your valves and carefully insert it in the first of the sockets in which you will use such a valve. If it lights, take it out and insert it in the second socket, third, fourth and so on, until you have tested this valve in each of the sockets which will ultimately have a valve of this type. Be careful not to try a .06 valve in a socket fitted with a 1-ampere filament resistance. Now try the other valves in their respective sockets and if all light up you are sure that the filament circuit is correct.

Preliminary Tests

Upon the completion of building the instrument, put the filament on-and-off switch to the “off” (in) position, turn the potentiometer knob as far as it will go in anti-clockwise direction, set the voltmeter switch in the middle position and the two dials at zero. See that fixed resistors of values suitable for the valves you are going to use are in their respective sockets,

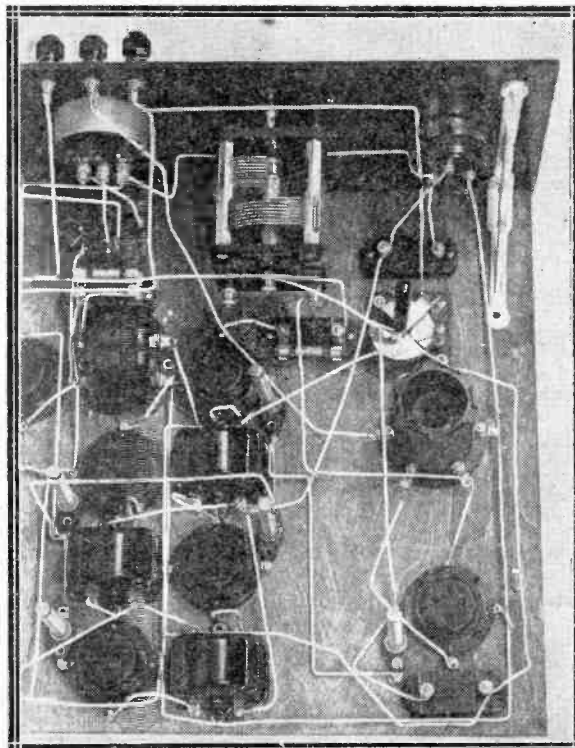

“General Radio of America” Transformers and “Silver-Marshall” Oscillator Coupler.

Test H.T. Connections

Withdraw all valves and join up H.T. negative and H.T. +1 to your high-tension battery or accumulator. Repeat the testing process and if all is well, join up H.T. +2 and again test all sockets. I know it is tedious to proceed in this way, but it has the merit of being safe and sure. A little trouble is cheaper than a set of new valves any time.

At the conclusion of these tests, place all valves in their sockets, join up high-tension and low-tension batteries, as well as grid bias, using for this latter the values suggested

THE "ALL-EUROPE" SUPERHETERODYNE—(Contd.)

by the makers of the valves on the cartons in which they are supplied.

Grid Bias Connections

Grid bias + can go to the positive terminal of a tapped grid bias battery, grid bias -1 to the tapping of the value suggested for the first note-magnifier and grid bias -2 to the value suggested for the second. Now take your frame aerial and connect its three terminals to the three on the top of the front panel, being careful that the centre-tapped terminal of the frame aerial connects to the centre terminal of the set.

There are a number of frame aerials obtainable of British and American manufacture, but in purchasing one it should be observed that it must have a centre tap. An excellent frame which I have used with this set and others for some considerable time is the Bodine collapsible frame, which will be seen on the front cover of last month's issue. This is obtainable from the same company as that supplying the Remler intermediate transformers.

Now as a final step connect up the loud-speaker by means of the plug. The knob of the volume control plug should be turned in an anti-clockwise position as far as it will go, and the plates of the reaction condenser inside the cabinet should be set so that the moving plates and the fixed plates are separated as far as possible; in other words, the condenser should be set at the zero position. You will probably hear nothing whatever as both dials are set at zero and the potentiometer is on the full positive side.

Using the Potentiometer

Now, without making any adjustment of dials, turn the knob of the potentiometer in a clockwise direction gradually, and when you have proceeded about a third of its travel you will probably hear a rushing noise in the loud-speaker. Turn the potentiometer knob back a little, until you are just before this position at which a rushing sound is heard, and slowly rotate the two dials simultaneously. You will soon find the position for your local station, and if you are using the Remler intermediates and the Bodine frame the positions will be very similar to those given in the table on page 105 of the last

issue. A different frame will bring different readings on the aerial condenser, while different intermediates will give different readings on the oscillator condenser.

Two Readings

For every station you will find two positions on the oscillator condenser. These will be separated by a distance depending on the particular make of intermediate you are using and the wavelength, or rather frequency, at which these intermediates amplify. The longer

greater at the top end of the scale than at the bottom.

For the time being ignore the reaction condenser within the cabinet and make yourself accustomed to the handling of the two dials and the potentiometer. The potentiometer knob will control the volume and sensitivity of the set to a very large degree, and it will be found that the maximum strength (apart from quality) is obtained when for a given setting of the two condensers on a station, the potentiometer knob is turned

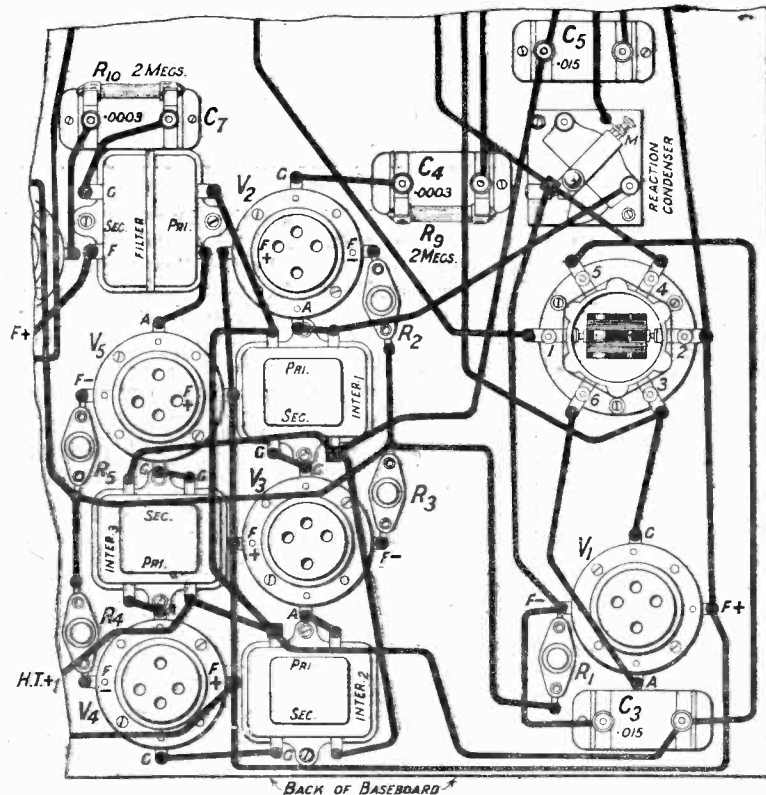

Fig. 1.—The wiring diagram for the "General Radio" transformers and "Silver Marshall" coupler.

the wavelength on which the intermediate frequency transformers amplify the closer will be the two readings. For example, on one make of intermediate operating at 10,000 or 11,000 metres, the separation at the bottom end of the scale may be only four or five degrees, while on intermediates operating on a 3,000 or 4,000 metre wavelength the separation may be more than twice this figure. In any case the separation between the two readings for the same station will be

as far to the right as it will go, without causing intermediates to oscillate. For best quality, however, this is too far to go, and as so many stations come in at very great strength, the set will be found to give far better reproduction if the potentiometer knob is kept away from the point where oscillation begins.

The Reaction Condenser

When you have become used to handling the set, you can operate

THE "ALL-EUROPE" SUPERHETERODYNE—(Contd.)

the two dials simultaneously and pick up the stations with ease (in so doing I should observe that you will frequently have to rotate the frame, for stations come in best when the plane of the frame is in the same plane as the line joining your set and the station you are receiving). When you have accustomed yourself to handling the set in this way, try the effect of adjusting the reaction condenser within the cabinet. You will find this increases the sensitivity of the set appreciably, particularly on distant stations.

Oscillator Coupling

So far I have made no reference to the setting of the rotor of the oscillator coupler. Generally this will be set at 45 degrees for the Remler, but it is best to experiment once you have picked up a weak station by trying various settings of the rotor until the best and clearest signals are heard. Once this position has been found it can be left and will not need attention again unless you are changing the type of valves you are using. The high-tension voltage of this set is not very critical, but it will be found that about 45 to 60 volts is best for H.T.1 and about 120 for H.T. 2. Here again there is a little scope for experiment on the part of the constructor.

Alternative Schemes

Since writing the article last month I have received a communication from San Francisco informing me that the Remler intermediate transformers have been withdrawn from the market at the present time and therefore there will be some difficulty in obtaining a supply. However, there are a number of other makes of intermediate transformers of high efficiency, and I have been

to some pains to test a number of different makes in this actual set, so that it can be built efficiently in the absence of the Remler transformers. For example, I have obtained very excellent results with the intermediate transformers made by the General Radio Co., of America. These are obtainable from Messrs. Claude Lyons, of Liverpool. The set consists of three intermediate transformers and one filter, and the wiring diagram and photographs for joining up these are given in the present issue. An oscillator coupler is required in addition to the kit supplied, and for this I have used the very excellent arrangement devised by Mr. McMurdo Silver of the Silver Marshall Co., of Chicago. The Silver Mar-

shall cover 50 metres to about 110, a second coupler to cover the ordinary broadcast band and the third to include the Daventry wavelength. The wiring up of this coupler is shown in the same diagram and photograph as the General Radio Co.'s intermediates. Another excellent series of intermediate transformers which can be used either with the coupler supplied by the firm or with the Silver Marshall oscillator and coupler is the Bowyer-Lowe, particulars of the wiring of which are also given in this issue. I have used Bowyer-Lowe intermediates with considerable success in the Seven-Valve Superheterodyne described in Radio Press Envelope No. 12. Whatever intermediates are used, the method

of operating the set is the same, and the only difference will be found in the separation of the two readings of the two same station. Notice that in all arrangements the filter goes at the end (*i.e.*, next to the second detector).

The Samson Intermediates

A further series of intermediate transformers which I have actually tested in this receiver and can recommend are the Samson. The Silver Marshall coupler is well suited to the Samson outfit, and I have used

it very successfully with them. Silver Marshall and Samson intermediates are obtainable from the same firm as that supplying the Remler, the Bowyer-Lowe from the Bowyer-Lowe Co., Ltd., of Letchworth, and the General Radio of America from Messrs. Claude Lyons. In using the Samson, as these are rather larger than the others, the valve-holders must be spaced a little more widely to take them.

The fact that there are a number of intermediates not mentioned in the present article must not be taken as a condemnation of the

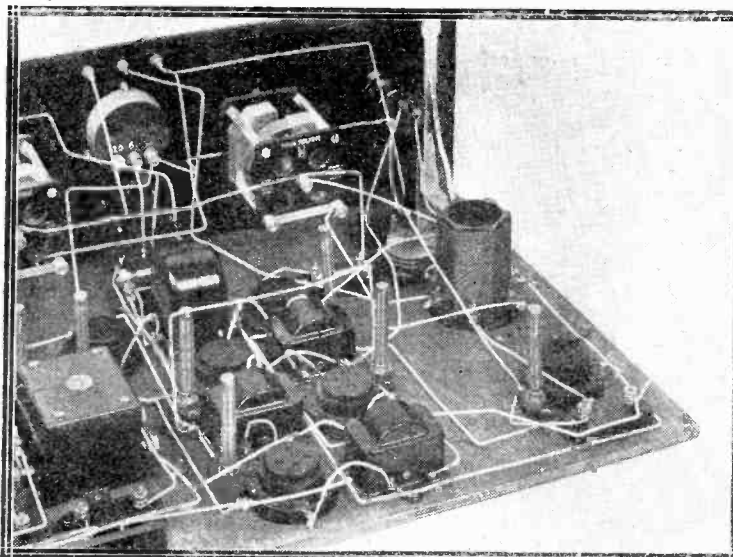

It is quite a simple matter to wire up any of the intermediate transformers mentioned.

shall intermediate transformers (which incidentally work excellently in this set) have already been described in this journal in the superheterodyne receiver designed by Mr. G. P. Kendall, B.Sc. The new Silver coupler has the advantage of allowing the very wide range of wavelengths to be obtained with the receiver.

Interchangeability

The coupling and oscillator coils are of the plug-in variety and immediately interchangeable, so that it is possible to plug in a coupler to

THE "ALL-EUROPE" SUPERHETERODYNE—(Contd.)

particular series, but merely as an indication that I have not personally tested them in the present instrument. Any of those named above should give excellent results.

A Suggestion

In the case of the General Radio Co.'s intermediates, it is suggested by the makers, and I found it a

that at Wimbledon, seven miles from 2LO, Manchester and Cardiff can be received free from London while the latter is working.

On each of the sets of intermediates named, I have run through the list on page 105 and have obtained them all within a few minutes when they have been working, together of course, with a very

up on each of the sets of intermediates, but owing to the fact that foreign stations vary in wavelength from day to day and rarely announce their names, it is very difficult indeed to identify stations accurately when there are so many and they are so close together. For example, on the lower end of the condenser scale it is possible to

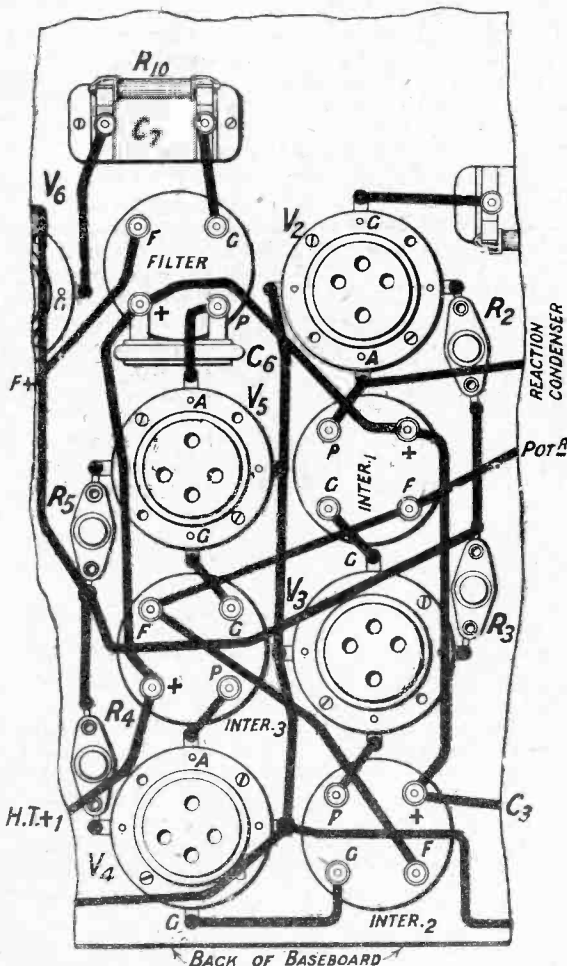

Fig. 3.—The Samson intermediates are joined up as shown on the right.

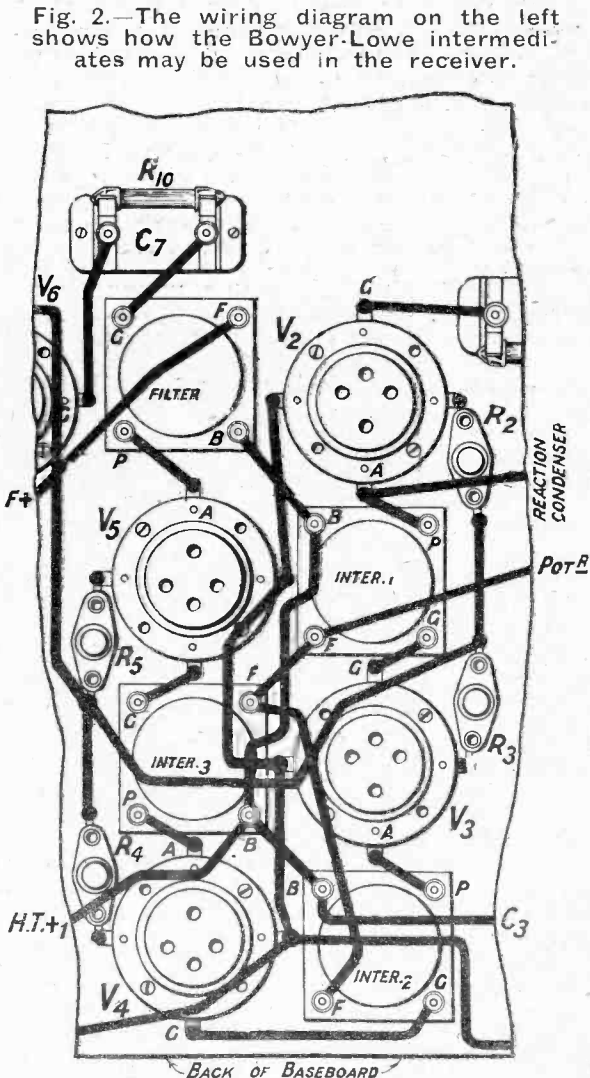

Fig. 2.—The wiring diagram on the left shows how the Bowyer-Lowe intermediates may be used in the receiver.

good plan, to try the effect of reversing the primary leads. The same remark applies to the Samson.

Test Report

The sensitivity is such that all the main relay stations can be received after dark, and a number of them during daylight.

The selectivity of this set is such

large number of others. For a receiver such as this the number of stations obtainable seems limited only by one's patience, and if you take a list such as that given each morning in the *London Times*, you will be able to run through them one after another with hardly a single "miss." I had intended to give a complete list of the stations picked

find stations (apparently mostly German!) every half degree. It is interesting to note, however, that in all my tests I have confined myself entirely to the loud-speaker for picking up the stations, and have not considered a station to be properly received unless it is clearly audible to everybody else in the room.

REMINISCENCES OF A PRE-BROADCAST LISTENER

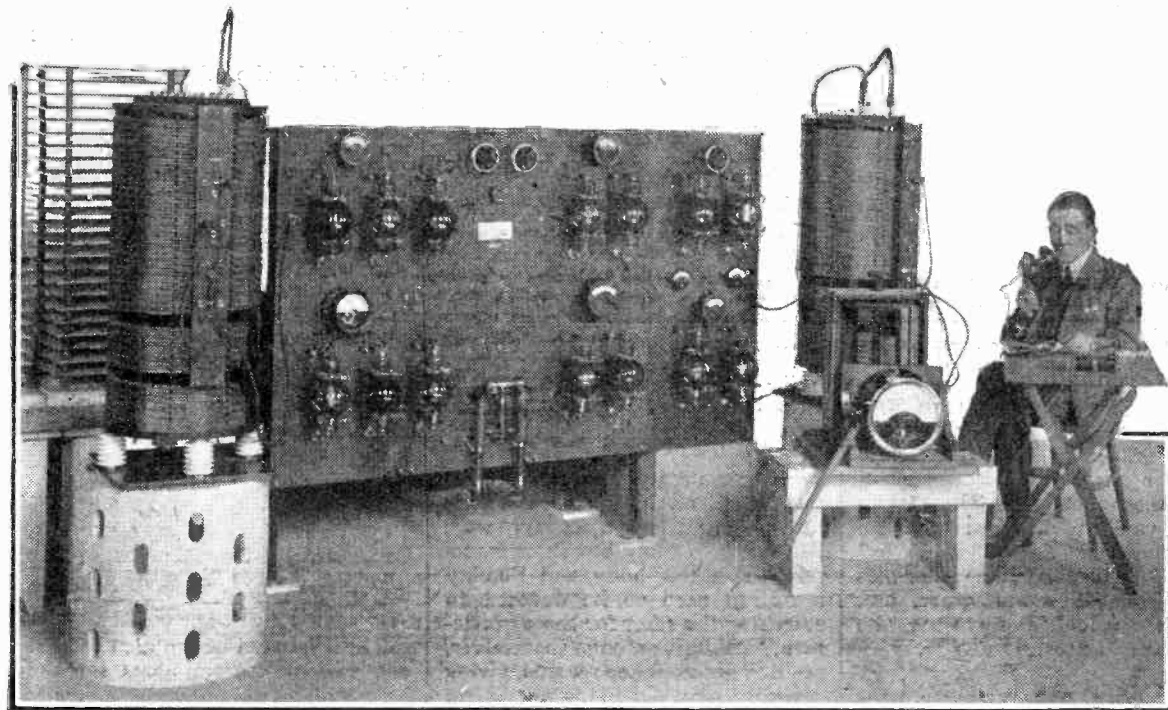

The transmitting panel at the Chelmsford station of Marconi's Wireless Telegraph Co., Ltd., as it was in 1920, when telephonic communication was maintained with the s.s. "Victorian" over a distance of 1,200 miles.



BROADCASTING has become so widely known and so popular that sometimes one wonders how we got on without it.

Millions of people have become so used to broadcasting, so much has it become a "habit" in their lives, that they switch on their sets with as much thought to the science of radio as one gives to the development of the petrol engine when boarding a motor omnibus.

Not Always So

In the days before broadcasting was thought of things were very different, yet none the less interesting. The listeners then were all keen radio men devoted to the development of the science, while the apparatus then at their disposal was both costly and crude when compared with the instruments obtainable to-day.

Even as long ago as 1910 there lived a little band of wireless enthusiasts whose main hobby was

radio, though their opportunities for reception were few. This little army, mostly confined to this country and the United States, spent the majority of their spare moments listening, not to broadcasting, but to telegraph signals transmitted by the "high power" naval stations and to the time and weather signals sent out by the Eiffel Tower.

Early Receivers

The apparatus used in those days, in so far as the receiver was concerned, was usually of the crystal type, but of somewhat crude design when compared with modern methods in receiver construction.

These receivers generally took the form of long cylindrical inductances, sometimes as long as 18 inches, wound with enamelled copper wire upon a cardboard tube. The required number of turns in use was obtained by fitting the inductances with one, two or sometimes three sliders according to the personal preference of the listener. Practically all apparatus was

home-made, including many of the components themselves, and though the majority of the sets used crystal detectors, a few were fitted with electrolytic and magnetic detectors.

Telephones in those days were massive pieces of apparatus weighing four or five times as much as the present phones, and were fitted with stiff steel bands that "bit" their way into one's head in a very short while.

Progress with Time

This type of apparatus was largely in use among the radio amateurs until the outbreak of war in 1914, when all activities in the amateur sense completely ceased until Europe took on its more peaceful appearance.

By that time the valve had become widely known, and for that matter had been used by many amateurs during their career in the services. At the same time wireless telephony was being practised in addition to the sister system of wireless telegraphy. Before the end of 1920 was reached many

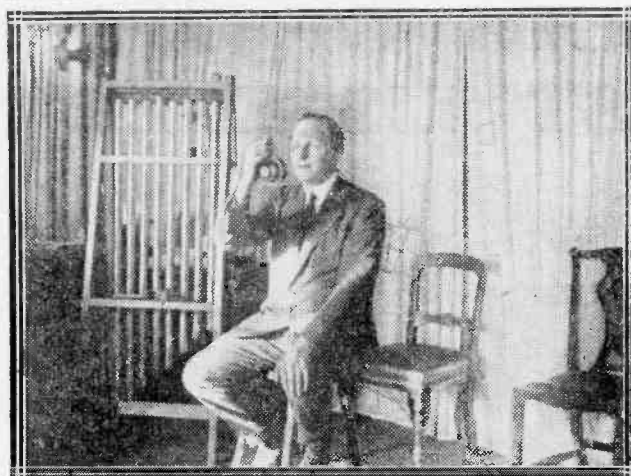

"The Voice"— Mr. Arthur Burrows, who was the "announcer" on the s.s. "Victorian" during the voyage of the Imperial Press Conference to Ottawa.

REMINISCENCES OF A PRE-BROADCAST LISTENER (Continued)



be called the first high-power broadcasting that was ever done.

The Imperial Press Conference was on its way to Ottawa from England on the s.s. *Victorian*, which ship was fitted with wireless telephony apparatus especially for the occasion. At the Marconi Works, Chelmsford, a high-power telephony station was built, and this installation maintained communication with the *Victorian* for quite an appreciable period, actually over 1,200 miles.

As a point of interest it is worthy of note that the *Victorian* conversed with the *Olympic* during the voyage over a distance of 750 miles, Lord Burnham, on the *Victorian*, actually speaking to Capt. Sir Bertram Hayes of the *Olympic*.

"The Voice"

The *Victorian* at sea also carried out various transmissions for the benefit of other ships on the Atlantic the service taking the form of

amateurs were in possession of valve sets, mostly of the single-valve variety, but nevertheless valve receivers. A few "wealthy" enthusiasts boasted four-valve sets of commercial manufacture, and these were looked upon as the *dernier cri* in receiver design.

What was to be Heard

At that time the telephony trans-

for the success of many demonstrations to one's friends! Likewise the transmitting amateurs were beginning to carry out their transmission in telephony, and Sunday mornings used to be devoted to searching the ether for these gentlemen, talking among themselves, sending gramophone records, giving pianoforte solos and so on. How many readers of MODERN WIRELESS,

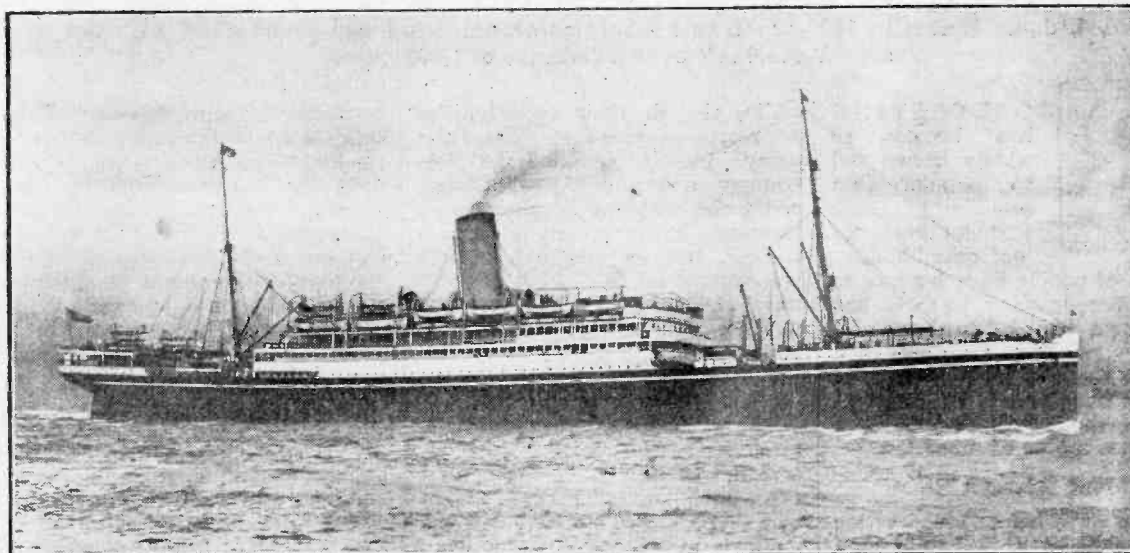

The s.s. "Victorian," now renamed the s.s. "Marloch," which carried out some experiments in long-distance telephony in 1920, with Lord Burnham on board.

missions which could be picked up were few and far between, but as time went on things became more accommodating in this direction.

The London-Paris Air Service became a good "broadcasting service," and in its time Croydon Aerodrome has been responsible

I wonder, remember the excellent transmissions of 2 OM?

An Important Occasion

During 1920 a really important experiment was conducted from Chelmsford, and this may perhaps

news bulletins, concerts and so on. The "announcer" on the *Victorian* was no less a personage than Mr. Arthur Burrows, the famous Uncle Arthur of 2LO, and so well did his voice carry that he became known to the public, through the *Daily Mail*, as "the voice."

A fascinating account of the things we used to listen for in the days when there was no B.B.C.

Writtle

The now well-known tones of Capt. Eckersley's voice were first heard by the radio public through the microphone at Writtle, Essex. This station, which was something in the form of an experimental transmitting establishment owned by the Marconi Company, used to work on quite small power on Tuesday evenings, and very well used the transmission to be heard.

Capt. Eckersley was the "announcer," "performer" and various other things all rolled into one, though sometimes other performers were put "on the air."

The transmission of Writtle used to be looked forward to by every radio enthusiast, for apart from the fact that the station was easy to receive, the transmissions were usually decidedly humorous to listen to.

The Hague

Another series of concerts which the pre-broadcasting listeners used

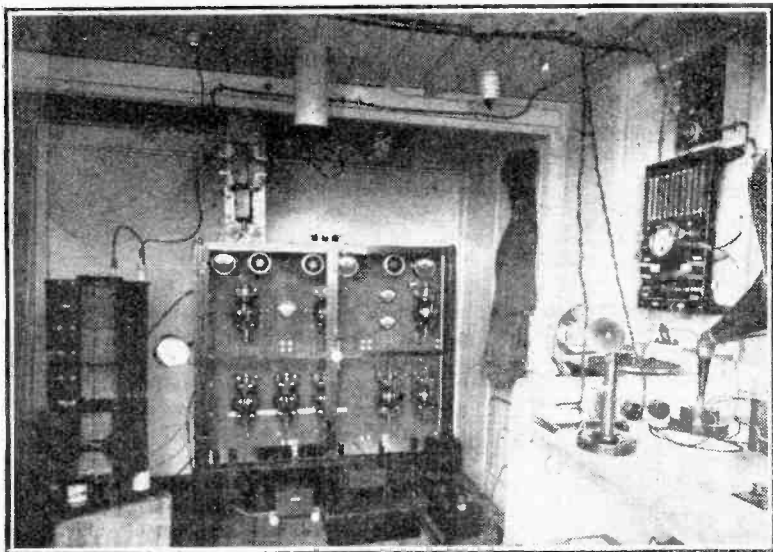

A special 3 kilowatt transmitter was used on the "Victorian."

to enjoy were those emanating from a station at The Hague, using the call letters PCGG.

This station used to work on Thursday evenings and Sunday afternoons, making its announcements in English. The programmes were made up of orchestrations, vocalists, pianoforte solos, humorists and so on.

In London the station was rather difficult to pick up, particularly on Sunday afternoons; furthermore, the tuning-in of this station used to vary. That is to say, whereas one day the signals would be quite loud, on another occasion

they would be hardly audible; on some transmissions, however, they have been received by the writer at full loud-speaker strength.

Some little while before broadcasting proper actually commenced, a special transmission was made by this station of a concert organised by the *Daily Mail*; the power was increased, the concert was largely

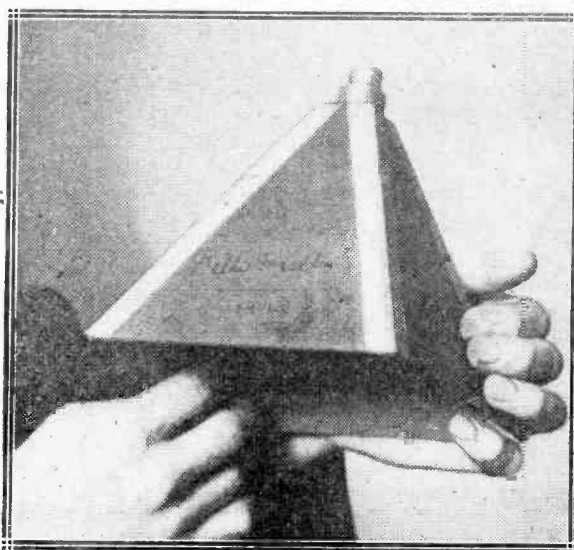

In the first experiments from Chelmsford a broadcast by Melba was a striking demonstration of the possibilities of the new art. This special microphone was used and autographed by the great singer.

advertised and many large firms handling radio apparatus in this country invited the public to their showrooms in order that they might hear the transmission.

On the whole, reception in this country was not a success, some firms managed to pick up one or two items of the programme, so did many amateurs, but the general feeling on the part of the public was that they had been "done," and that wireless had a long way to go before it could be regarded with any serious thought as a means of entertainment.

The First Melba Transmission

An historic occasion in the broadcasting world is that upon which the voice of Dame Nellie Melba was broadcast for the first time.

Components and Prices

One of the things which stand out very forcibly is the difference in price of the old and new components. Looking at some advertisements in wireless papers dated 1920, L.F. transformers are priced therein at £2 and £3; while 3-coil holders cost as much as £2. Variable condensers, rated '001 capacity, are priced at £2 10s. each; while a complete single-valve set, without batteries and valves, had a price ranging from £15 to £42.

On the whole, the present-day listener has much to be thankful for, though it must be admitted that the "old days" were equally as interesting as are the present times.

S. G. R.



The "HOLIDAY TWO"

By John Underdown.

This simple two-valve portable set is just the thing for your holidays. An efficient frame aerial is incorporated in the design, but if desired an ordinary aerial and earth may be employed.



At last the long-awaited holiday! With kind treatment from the weather what use have we for a wireless set? None at all, you say on first thoughts. And yet, think!

Newspapers are perhaps a day late, a by no means unusual thing when we get off the beaten track, and we feel that we have partly lost touch with civilisation. In such cases wireless, appreciated at home, comes still further into its own if we have only a portable set.

After long days of tramping, motoring or fishing, utterly tired, we wish to be amused in a quiet way. Lazing at ease, the pipe drawing well, a pair of 'phones and a good programme, how better could we finish the day?

Before our final choice of the portable receiver for the holidays is made it is as well to outline the

conditions under which it will be used. If to be used by only two or three listeners in the evening,

telephones will generally prove satisfactory, making it unnecessary to carry a somewhat bulky loud-speaker, and the heavy batteries which will be required by sets to give loud-speaker results. The set must be flexible so that it will work off a frame if necessary, or can be employed with a small temporary aerial, an ordinary or no earth connection, or perhaps by utilising the electric lighting wiring of the hotel or boarding house as the aerial.

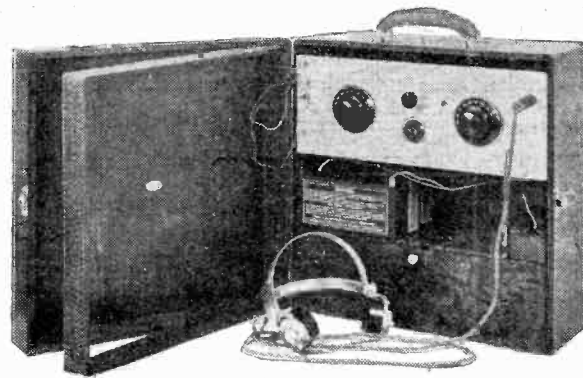

Since the set generally will be used at some distance from the nearest broadcasting station, its range should be good, its tuning should be simple, the case should not be unduly large or weighty, and the batteries should be reasonably small.

How Many Valves?
The number of valves should be kept to a minimum, but for reliable

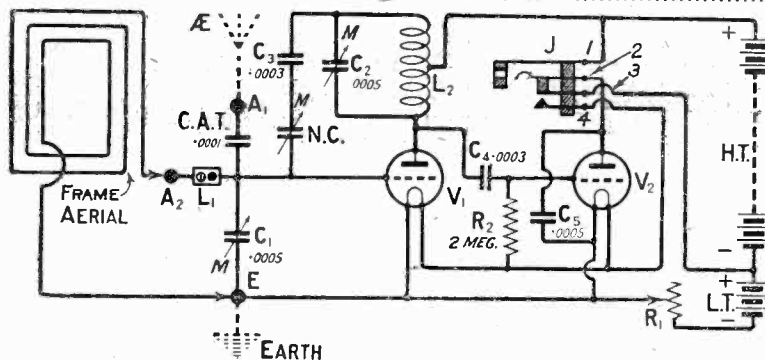

Fig. 1.—If desired the receiver may be used with a small aerial and earth, in which case A₂ and E would be joined and a suitable coil inserted in L₁.

THE "HOLIDAY TWO"—(Continued)

reception over fair distances it is not safe to rely upon a detector valve only, and an efficient stage of high-frequency amplification is to be advised. To get the best from the receiver some reaction control should be fitted, and one which takes up little extra room, adds practically no extra weight and is simple to use, makes its appeal.

Giving due consideration to these points I decided to employ the two-

size of aerial coil may be inserted into E_1 and a small aerial and earth, as shown dotted, may be employed.

The neutralising condenser NC is employed as a reaction control, slightly upsetting the balance which gives maximum stability, providing the necessary reaction effects. In series with this condenser is a fixed .0003 condenser C_3 , which acts as a safeguard if through any undue happening NC should short.

In the anode circuit of the

reading from top to bottom, A_1 , A_2 and E. The frame or aerial tuning condenser, which is of geared type, is placed on the left-hand side of the panel, and the tuned-anode condenser is on the right. The single filament rheostat for the two valves is in the centre of the panel and directly above it is the neutralising condenser, which acts as a reaction control also. The telephone-jack is on the extreme right-hand side.

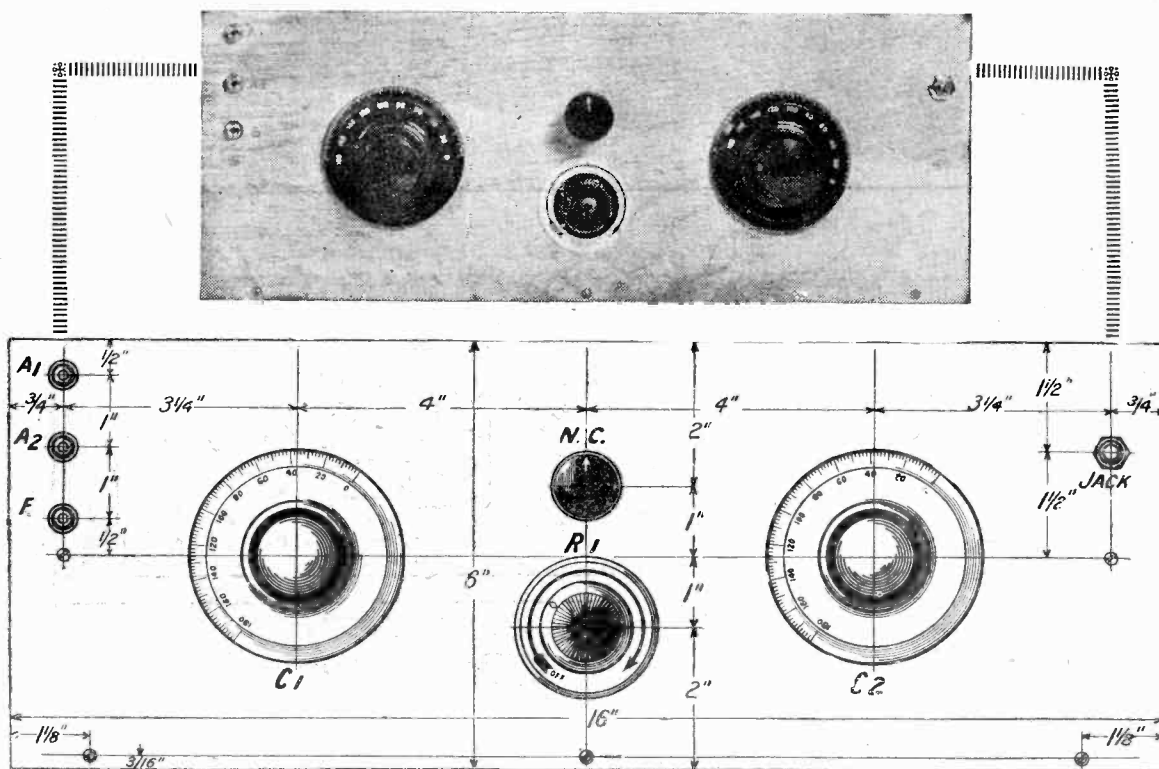

Fig. 2.—The panel lay-out is both attractive and simple. A full-sized Blue Print, No. 169a, may be obtained free.

valve circuit seen in Fig. 1 for my holiday set.

The Theoretical Circuit

The technical details of the receiver will be appreciated from this diagram. It will be observed that the high-frequency stage employs tuned-anode coupling. In the grid circuit of the high-frequency valve is a small frame, which can be loaded by insertion of a suitable coil in the E_1 coil socket, or alternatively terminal A_2 may be joined to E, a normal

detector valve a filament single-control jack is employed, and when a telephone plug is inserted the valves are automatically lit.

General Lay-out

The receiver proper follows a conventional lay-out, but for lightness the vertical panel is made of $\frac{3}{16}$ in. thick oak, instead of ebonite.

Upon the left hand side of the panel three Clix sockets, mounted in insulating bushes, will be seen. These are the three aerial terminals.

Battery Arrangements

The receiver proper is mounted in the upper portion of a standard Camco portable receiver case, and directly below it, upon a platform, is placed a 60-volt H.T. battery. I have slightly modified the inside arrangement of the case, cutting away a portion of the shelf so that two Oldham "Non-spill" batteries may stand on the right-hand side.

The Frame Aerial

The frame aerial is wound upon a standard wooden framework,

A TWO-VALVE PORTABLE RECEIVER

15 $\frac{1}{4}$ in. square and 1 $\frac{1}{2}$ in. wide. 16 turns of 9/36 Litzendraht wire are required, the turns being spaced 1/10 in. The corners of the wooden

Components Required

The components which I have employed in the receiver are as

important that geared condensers, giving fine tuning, be utilised if it is likely that the frame will be used alone.

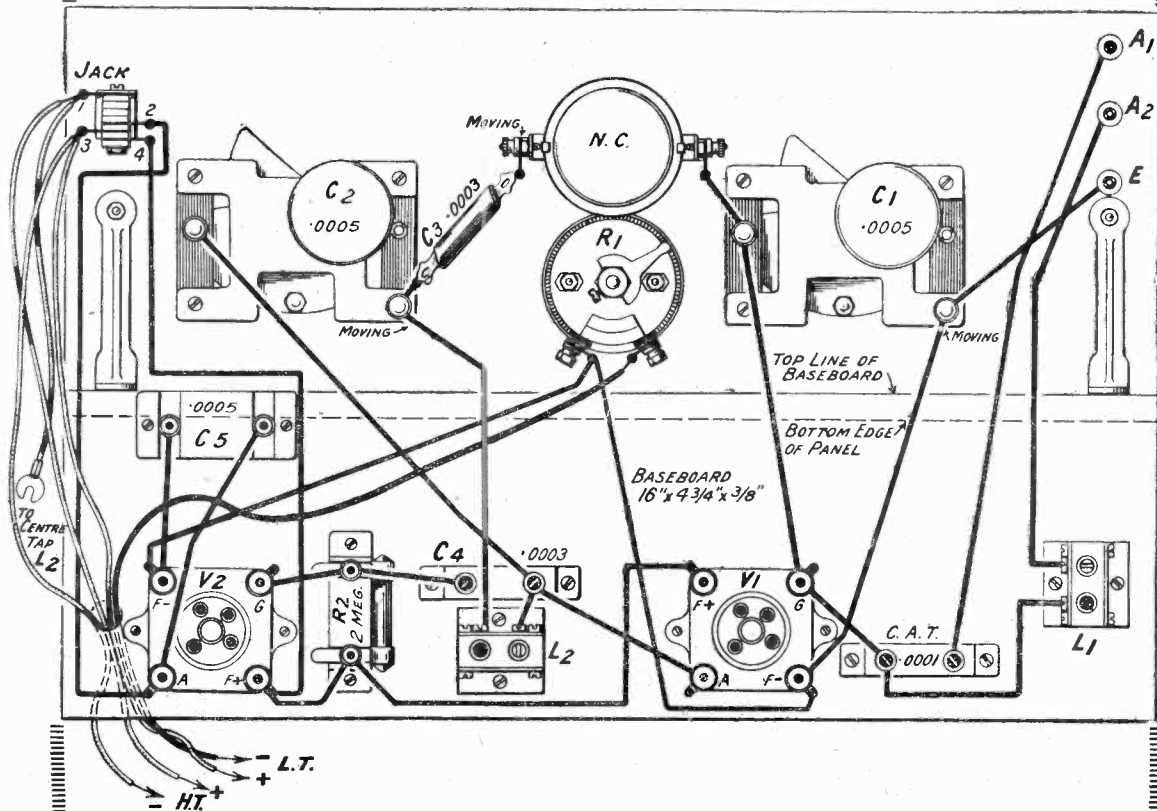
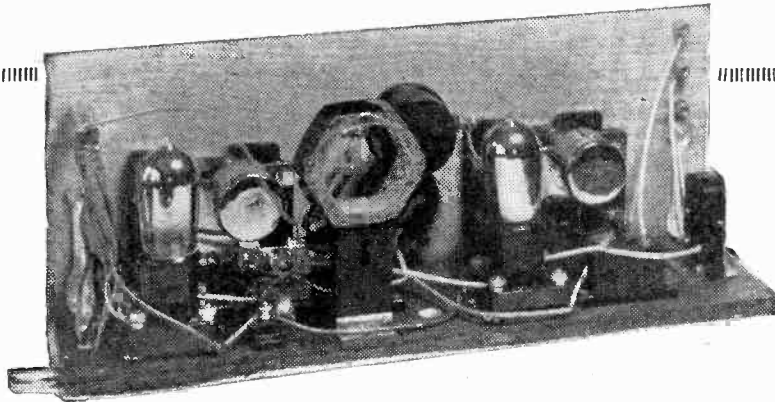

Fig. 3.—For a receiver of this type the author recommends the use of fairly thin wire covered with insulating sleeving. Constructors should ask for Blue Print No. 169b, free.

framework are notched by means of a hacksaw to keep the turns in position, and the two ends of the winding are brought out and terminated by two Eelex plugs.

follows, manufacturer's names being given for the convenience of the reader. Other components of good make, if to hand, may be substituted in a number of cases, but it is

1 Standard oak portable receiver case (Carrington Manufacturing Co.).
 1 Oak panel, 16 in. by 6 in. by $\frac{3}{16}$ in. thick (Carrington Manufacturing Co.).

THE "HOLIDAY TWO"—(Continued)

2 .0005 square-law geared variable condensers (Ormond Engineering Co., Ltd.).

1 Igranic micro-vernier condenser (Igranic Electric Co., Ltd.).

1 2 megohm Dumetohm leak, 1 Dumetohm holder (all Dubilier Condenser Co., Ltd.).

1 .0003 condenser (Igranic Electric Co., Ltd.).

soldered joints and stout straight wires should not be employed. In travelling, if stout wire is used, unless the soldered connections are particularly well made, the vibra-

WIRING INSTRUCTIONS

Join one side of R1 to F- of V2, thence to one side of C5. Also join same side of R1 to F- of V1; F- of V1 to moving plates of C1; and moving plates of C1 to E.

Join one wire of filament twin flex to remaining side of R1.

Join remaining side of C5 to A of V2, thence to contact 2 of Jack.

Join moving plates of C2 to one side of C3 and to socket of holder for L2.

Join fixed plates of C2 to one side of C4, thence to A of V1 and pin of holder for L2.

Join fixed plates of C1 to fixed plates of N.C. and to G of V1; G of V1 to one side of C.A.T., and same side of C.A.T. to socket of holder for L1.

Join A2 to pin of holder for L1.

Join A1 to remaining side of C.A.T.

Join moving plates of N.C. to remaining side of C3.

Join contact 4 of Jack to F+

of V2; F+ of V2 to one side of R2; same side of R2 to F+ of V1.

Join G of V2 to remaining side of R2, thence to remaining side of C4.

Join flex wire with spade tag for centre tap of L2, and flex lead for H.T.+ to contact 1 of Jack.

Join remaining wire of filament twin flex, and flex for H.T. — to contact 3 of Jack.

1 30 ohm Pacent filament resistance (Igranic Electric Co., Ltd.).

3 Clix sockets with insulating bushes (Autoveyors, Ltd.).

1 Filament control single circuit jack (Bowyer-Lowe Co., Ltd.).

2 "Clearertone" valve holders (Benjamin Electric Co.).

2 Single coil holders (Burne-Jones and Co., Ltd.).

2 small aluminium panel brackets (Burne-Jones and Co., Ltd.).

Quantity of 20 gauge tinned copper wire, insulating sleeving, rubber covered flex and red and black twin covered flex.

1-lb. 9/36 Litzendraht wire (London Electric Wire Co.).

4 Eelex plugs (J. J. Eastick and Son).

tion is liable to cause a number of joints to become defective.

To overcome this difficulty I use thin wire, 20 or 22 gauge tinned copper, covered by insulating sleeving. Instead of straight wires direct from point to point more sweeping curves are taken, and leads are screwed under terminal heads as far as possible.

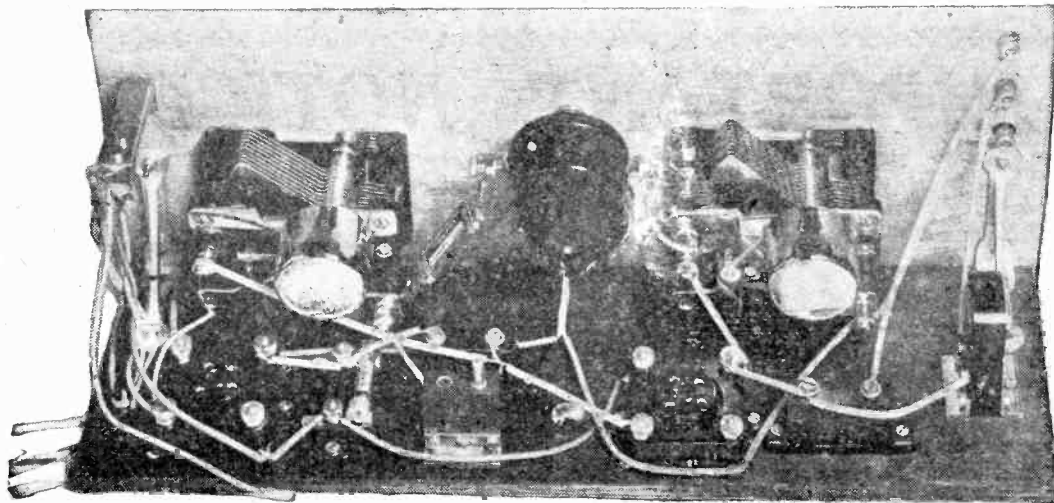

The coil holder on the extreme right is for a loading or aerial coil. For broadcast reception with a frame a short-circuiting plug is inserted as shown.

1 Shorting plug (Peto-Scott, Ltd.).

1 .0001 type 620 fixed condenser,

1 .0003 type 620 fixed condenser,

1 .0005 type 610 fixed condenser,

The Wiring

The wiring of a portable receiver presents a distinct problem from that of the home set, and the usual

Soldered joints are only utilised in one or two places, and here the wires are twisted together several times before the soldered joint is made.

THE "HOLIDAY TWO"—(Concluded)

Twin flex, with red and black cotton covering, is employed for the L.T. battery leads, whilst those for the H.T. are made with rubber covered flex. This latter type of wire can, if you so desire, be utilised throughout for wiring.

Valves and Batteries

Since economy of filament consumption is one of the main considerations for a holiday set, I generally employ two .06 ampere valves and run them from the 4 volt Oldham "Non-spill" battery seen in the photographs. In the various tests which I have carried out two Electron S.S.3H.F. type valves have been employed with 60 volts H.T.

Testing the Set

If your local station is a main station comparatively close, say, up to ten miles away, you can test upon the frame aerial, the two ends of this winding being inserted into the A₂ and E sockets, whilst a shorting plug is inserted in the L₁ coil socket. For L₂ a centre-tapped Lissen 60 coil should be utilised, the short flexible lead from the upper contact of the jack being taken to the side terminal on the coil.

Upon the frame, tuning will be exceedingly sharp, and at twelve miles south-east of 2LO, it took me five minutes to find that station.

An Outside Aerial

Matters are easier, of course, if you test the receiver upon an outside aerial, this being connected to A₁ and the earth to E, the frame now acting as an ordinary aerial coil. The test should not be carried out during broadcasting hours,

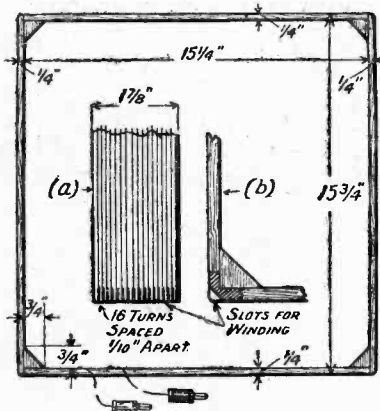

Constructional details of the frame aerial.

since when first connected the receiver is almost bound to oscillate until the neutralising condenser is adjusted. Adjustment of this latter may be carried out without the outside aerial and earth connected by setting C₁ at some intermediate value, say, 50 degrees, and by

rotating C₂ when oscillation will be announced by clicks about a certain setting. NC should now be adjusted by tapping the grid socket of V₁, when a point will be found where the receiver becomes completely stable.

Receiving Daventry

Daventry can be received by loading the frame with a number 200 or 250 coil, a further centre tapped 250 being employed for L₂, but here it is much better to employ a small temporary aerial. When this is done the frame may be left in circuit or alternatively A₂ may be joined to E, E to earth, and a short length of flex may be connected from A₁. Here with a ten-foot length of flex taken across the room to the picture rail, I received good telephone strength from 5XX.

Test Report

Tested at twelve miles south-east of 2LO excellent telephone strength was obtained upon the frame alone, the tuning being exceedingly sharp. With a number 250 Lissen coil for L₁, and a number 250 centre-tapped coil of the same make for L₂, Daventry gives fair telephone strength upon a frame, and by coupling up ten feet of flex to the A₁ terminal, the flex being arranged across an ordinary room, really good telephone strength results.

IMPORTANT NOTICE!

COPYRIGHT

Notice is hereby given that articles, test reports, &c., contained in this Journal, are copyright and may not be reproduced in whole, or in part, without written permission from the Publishers.

In view of the important technical developments forthcoming from Elstree and the evolution of new designs and circuits, it is considered reasonable to indicate to all concerned (including readers of this Journal who may write for other papers) that RADIO PRESS, LIMITED, will take the necessary legal action where unfair advantage is taken of their Publications.

Development work is very costly and is conducted by the Publishers for their own readers. The reproduction in other Publications of the material and information gained is, apart from other considerations, a gross act of unfairness.

In the past RADIO PRESS, LIMITED, have by legal action in the High Court and by other means protected their Publications, and it is their intention to continue to do so.

It is also desired to point out that the word "Elstree" as applied to radio apparatus and the names of most of the receivers described in Radio Press papers are trade marks.

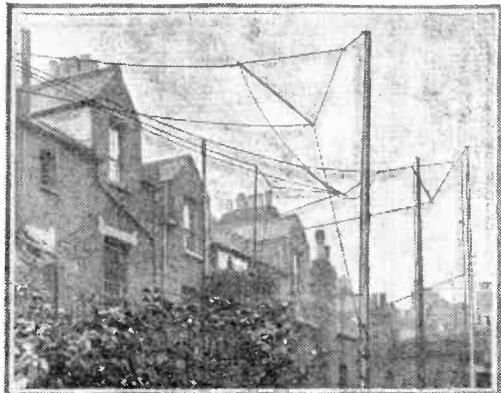

IMPROVING YOUR AERIAL

By G. P. KENDALL, B.Sc.

When trying to obtain better results do not forget the often neglected aerial, suggestions for improving which are given in this article.



ITS of the fever, at times, attack most of us, for improving various parts of our installation, generally when we feel that we know only too well just what the set will do, and begin to long for yet more stations and better results. At such times

we are perhaps apt to concentrate upon such matters as fitting better tuning coils, trying a variable grid-leak, and so on, rather forgetting that there is one part of the installation which can affect our results for good or ill almost more than any other, and that is the aerial.

Why Not?

Why not try to improve it? The great majority of aerials erected under suburban conditions leave plenty of scope for improvement, and, after all, very little expense is involved in any alterations which may be made. Take first the question of the height of the aerial, and here it must be understood that we are to consider the effective height rather than the actual height above the surface of the ground. Within certain limits the actual height above the ground of an aerial is not a very vital matter from the receiving point of view; but its effective height as compared with all objects which may act as screens is of the greatest importance.

The Down-lead End

I suppose that the majority of amateur aerials are supported at the further end by means of some sort of pole or mast, while at the down lead end they will be attached to some portion of a building. The height of the further end is there-

fore, more or less, fixed once and for all by the type of mast available; but the house end is usually amenable to treatment. For example, many aerials are simply made fast to a chimney, and thus their effective height at the down-lead end is very little above the roof of the house. This is very often a suitable point for experiment, since a very short pole, say, 8 feet long, will serve to lift the aerial well above its surroundings, and is very easily attached to a chimney, provided that the necessary long ladder can be obtained for the purpose. This is particularly worth trying if you find that there are signs of screening apparent in the long-distance which you can achieve, such as a difficulty in getting stations in one particular direction on nights when they are coming in well from other directions.

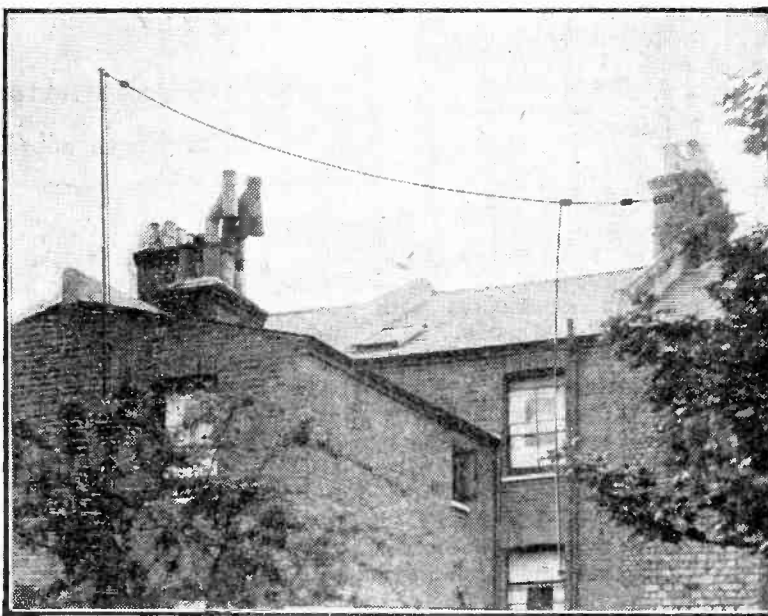

Keep your lead-in well away from the wall.

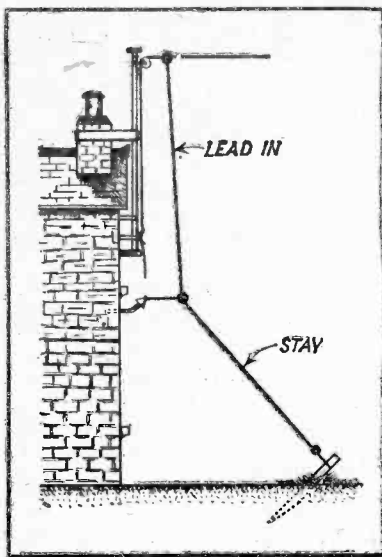

A stay fixed to the lead-in by an insulator will conveniently hold it away from the wall.

IMPROVING YOUR AERIAL (Continued)

Surroundings

Now take a look at the aerial and see whether it runs very close to any objects which are liable to be exercising an objectionable influence upon it. For example, does it run close to any iron fall pipes? If the aerial seems capable of improvement in this direction, try the effect of some light cords attached by way of suitable insulators to the aerial in such a way that it can be pulled away from the objects which are thought to be impairing results. A very little experimenting in this way will show you whether your aerial is really capable of much improvement of this sort, and if the results warrant it you can then proceed to make the alteration permanent.

Breaking the Guys

Next, what about the stays used to stiffen the mast? If they are of steel rope or wire, it may be that a particularly long length running close to the aerial may be having an objectionable effect upon reception, and it may be worth while to try "breaking" one or two of these long lengths with light insulators, such as those of the small reel type. As an instance of the kind of thing which may result from such an improvement as this, I will quote one of my own experiences with the outside aerial which I am now using.

At the house end this aerial is supported upon a short pole attached to a chimney, this pole being stayed with a long steel wire to withstand against the pull of the aerial. This steel guy comes in moderately close proximity to the down lead, and is of very considerable length. Early in the history of my aerial I had an insulator inserted in the middle of this guy, and found that the result was that a given set would oscillate very perceptibly more easily, and that the tuning of a given station had been altered by not less than ten degrees

upon a condenser dial!

Cleaning Insulators

A point which must not be overlooked concerns the insulation of the aerial, and this is a matter which is usually attended to with a reasonable degree of care by the average erector of aerials. Although an aerial may have been well insulated in the first place, however, it by no means follows that it will maintain that desirable state of affairs indefinitely without attention. Insulators made of porcelain are probably some of the most permanent in character, but even they are the better for an occasional cleaning to remove the deposits of soot; while insulators made of some of the substances of the ebonite type require rather frequent attention under town conditions, since some of these materials are very apt to be corroded by atmospheric conditions, and become quite passable conductors whenever they are rained upon. Polishing up with emery paper and a light rubbing with vaseline is probably the best remedy in such a case; but if it is found that an insulator really does deteriorate rapidly and cause leakage, it is far better to scrap it and fit one of the many good porcelain types now available, of which the cost is really quite low.

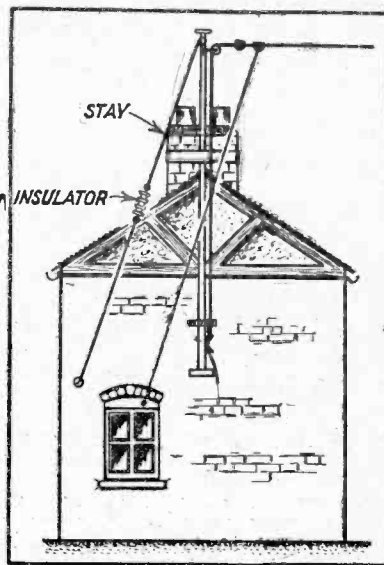

The effect should be tried of putting an insulator in wire stays which run near to the lead-in.

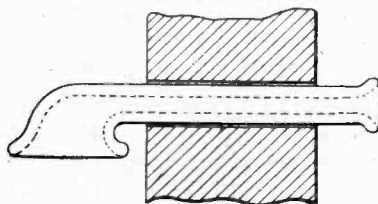

One of the best types of lead-in tube consists of a porcelain tube shaped as shown above.

The Lead-in

The insulators at the end of the aerial are usually a quite simple matter to attend to, but the leading-in tube is by no means so straightforward an affair, since its functions are rather different from those of the plain type which has only to separate the end of an aerial wire from the halyard. Now, there are many types of leading-in insulator upon the market which are thoroughly bad and inefficient, and I would strongly advise anybody who has one of these upon his aerial



Efficient insulation of amateur aerials does not present anything like so difficult a problem as that of a high-power transmitting station. The photograph shows some of the huge insulators at Rugby.

to scrap it at his very first attempt at improvement and fit some reliable type, either made of porcelain with a down-turned outer end, or one of the various skirted types upon which it is arranged that a certain area shall always be kept dry, even during rain. The crude type, consisting simply of a piece of ebonite tube with a piece of threaded brass rod through the centre, is my pet abomination, since unless it is made of really good material directly it gets dirty and wet it is exceedingly prone to set up serious leaks.

One of the very best leading-in insulators was the old porcelain tube with a crook in its outer end to prevent rain entering, while the more modern type, which is fitted into a hole drilled in the middle of the window frame, is also exceedingly good.

A Standard

The final test to be applied to a leading-in insulator is this: does it maintain its perfect insulating properties in wet weather, even after prolonged exposure to the atmosphere? If the answer to this question is not an unhesitating affirmative, scrap that insulator at once, and find one which complies with the requirements.

Lightning

Now what about lightning protection? Although questions of protection from lightning do not perhaps affect the results which a given set will

IMPROVING YOUR AERIAL

(Concluded)

produce when connected to your aerial, adequate protection from lightning is nevertheless a very important question, since it may have a great deal to do with one's peace of mind when awakened by a thunderstorm in the middle of a summer's night. Nothing is more aggravating, and I speak from experience, than having to turn out of bed at two o'clock in the morning and go down stairs and earth an aerial which is perhaps emitting sparks when brought near to the earth terminal. If you have not already got adequate lightning protection, take my word for it, and insure your peace of mind by fitting either a very good and substantial change-over switch on a porcelain base, so that you can connect the aerial to earth simply by throwing the switch over, or else some well proved design of lightning arrester.

I am a little dubious about many of the lightning protective devices other than the switch variety, since it seems that if some of them were called upon to function by a really healthy flash of lightning, heavy arcing would almost inevitably result, with some risk of fire. Some, of course, are perfectly safe, and it is not to be thought that I am condemning all and sundry. They have, of course, the attraction that they do not require to be actually switched over when leaving the set for the night, so that if a thunderstorm comes on while you are out during the day there is no need to worry, since the protection is automatically arranged. I may be old-fashioned, but I still prefer the earthing switch, provided that the user can make a definite habit of earthing the set whenever he switches off.

Placing the Switch

The actual position for an earthing switch is a matter of some argument, since upon grounds of safety it should certainly be outside the window, but the difficulty then arises of keeping it dry, and it seems that it is necessary to provide a small shelf above it to throw off the rain.

It is undoubtedly safer to have it outside, since lightning flashes are not desirable things to lead into the house just for the purpose of taking them out again along another lead. Although it might be quite safe, one has a nasty feeling that sparks might occur.



From my Notebook

By
H. J. BARTON-CHAPPLE,
Wh. Sch., B.Sc. (Hons), Etc.



THE question of reception during magnetic storms is still a subject for wide investigation, as the results obtained are very curious and lead to all manner of conjectures in an effort to explain certain phenomena. Some interesting results have been obtained at the Meudon Observatory, near Paris, in connection with the reception of wireless signals from the Rome and Bordeaux stations during times of magnetic disturbance.

A few weeks ago when a magnetic storm of fifteen hours' duration was indicated on the delicate recording instruments employed for this specific purpose, measurements of signal intensity from Rome and Bordeaux showed a considerable increase in strength. In the case of the former station the reception was about four times louder than usual.

I SUPPOSE that nearly everyone is aware that the United States of America heads the list in the stations; in fact they possess more stations than all the other countries put together. There are many people, however, who look upon this as somewhat of an unfortunate blessing.

It may interest readers to know that Canada holds the second place with eighty-three stations, while at the present time Great Britain takes fifth place on the list.

WHEN a jarring or rattling sound is heard in the telephones or loud-speaker it is quite probable that your receiving set has developed a loose connection. Perhaps the easiest way to investigate this trouble is to employ a small wooden rod with which the individual wires can be tried by pushing against them. On touching the one that is loose a distinctive sound will be heard from the loud-speaker or telephones.

This small test should be carried out with the local station tuned in, so it is imperative not to employ any rod of a metallic nature (a screwdriver for example) as there is a danger of short-circuiting the high-tension or low-tension batteries.

QUITE recently the world's debt to Dr. Alexander Graham Bell was acknowledged when the jubilee of the telephone was celebrated. The story of the development of this invention reads more like a romance, for Dr. Bell's initial motive for designing the first instrument arose from a humane desire to assist the deaf. As is the case with many inventors his early work was ridiculed, but he had the courage of his own convictions and won through.

In the course of a speech broadcast by Sir Oliver Lodge during the celebrations, he paid a fine tribute to the work of Graham Bell in the following words: "If I were asked to say what the greatest invention of the nineteenth century was, I should be disposed to say the telephone, for not only has it had a wide effect in extending human intercourse, but it has put a valuable device into the hands of inventors and research workers."

SPEAKING of telephones, or more strictly telephone receivers, it is a remarkable fact that amongst all the various pieces of wireless apparatus in common use at the present time they are really the least altered since the models of the early days. Are we to infer from this that telephone design has reached its maximum efficiency, or will the next few years reveal some remarkable departure which will make our present telephone receivers quite out of date?

WITH many listeners and users of wireless apparatus, if any objections are voiced concerning receivers in general and their attendant accessories, mention is often made of the unfortunate necessity for changing the accumulators or the serious defect of dry cells due to

FROM MY NOTEBOOK — (Concluded)

their variability. Of course, in the case of the latter there are many good makes now on the market, but the fact remains that after a time the dry battery voltage drops, the internal resistance increases and the quality of the reception is impaired. It is for this reason coupled with that of convenience and economy that so much attention has been given to receivers which can operate direct from the house lighting or power supply mains. Of course various precautions have to be taken, and additional apparatus is required, but with suitably designed smoothing units or rectifying accessories the receiver can be operated from an ordinary small tumbler switch. This is an advantage which recommends the mains receiver to all, and we can expect great developments in this direction in the near future.

♦ ♦ ♦
WE have got so much into the habit of connecting one end of the grid leak to the positive leg of the filament in the case of the rectifying valve that we often overlook the fact that with four- and six-volt accumulators an excessive positive bias is given to the grid with certain types of valves. In addition to exercising an excessive drain on the high tension battery the efficiency of the detector valve is thus often impaired.

The incorporation of a potentiometer will remedy this trouble when it arises; while if this is not desired a lead from the intermediate two- and four-volt connections of the low-tension accumulator can be taken and joined to the lower end of the grid leak.

♦ ♦ ♦ ♦ ♦ ♦ ♦ ♦
I HAVE heard it mentioned that a broadcasting station of very high power will soon start operating in Bavaria. The exact location of the station is in Hertzogstrand, and if the experiments in speech and music modulation are successful, as much as fifty kilowatts will be employed for broadcasting purposes.

It has been stated also that the aerial for this station will be stretched between two neighbouring

mountain peaks, so that difficulties in height will not present themselves.

♦ ♦ ♦ ♦ ♦ ♦ ♦ ♦
THE significance of reaction, either of the magnetic or capacity types, for increasing signal strength is not always appreciated readily by experimenters until attention is turned to frame aerial receivers. The small size of the aerial automatically limits the strength of the received signals, and unless an undue number of valves are contemplated a form of reaction must be added to give adequate loud-speaker volume, and from some experiments I have been conducting recently I have been led to the conclusion that magnetic reaction with capacity control gives the best results.

♦ ♦ ♦
WHEN capacity control of reaction is used, by the way, it often happens that the condenser performing this function has the full voltage of the H.T. battery across its two sets of plates. This fact should be borne in mind if any troublesome scratching noises are heard due to the rotation of this condenser, as these latter are often caused by leakage of the H.T. battery across some dust which has accumulated on the plates. This is most easily

cured by connecting a large fixed condenser in series with the variable.

♦ ♦ ♦ ♦ ♦ ♦ ♦ ♦
IN my opinion one of the best forms of capacity-controlled reaction is that which employs a variable condenser connected across a high-frequency choke, the whole arrangement being connected between the reaction coil and the telephones (or transformer primary if a note-magnifier is used). This gives a smooth control which has hardly any effect upon the wavelength. It also eliminates the "scratchy" noises I have just referred to, without necessitating the use of a fixed condenser in series with the variable condenser.

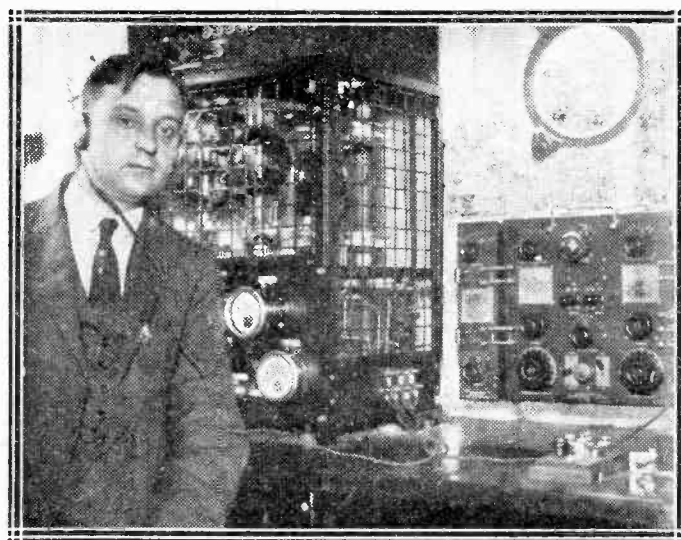

The Government whaling research vessel, the "William Scoresby," is equipped with a very compact and up-to-date installation.

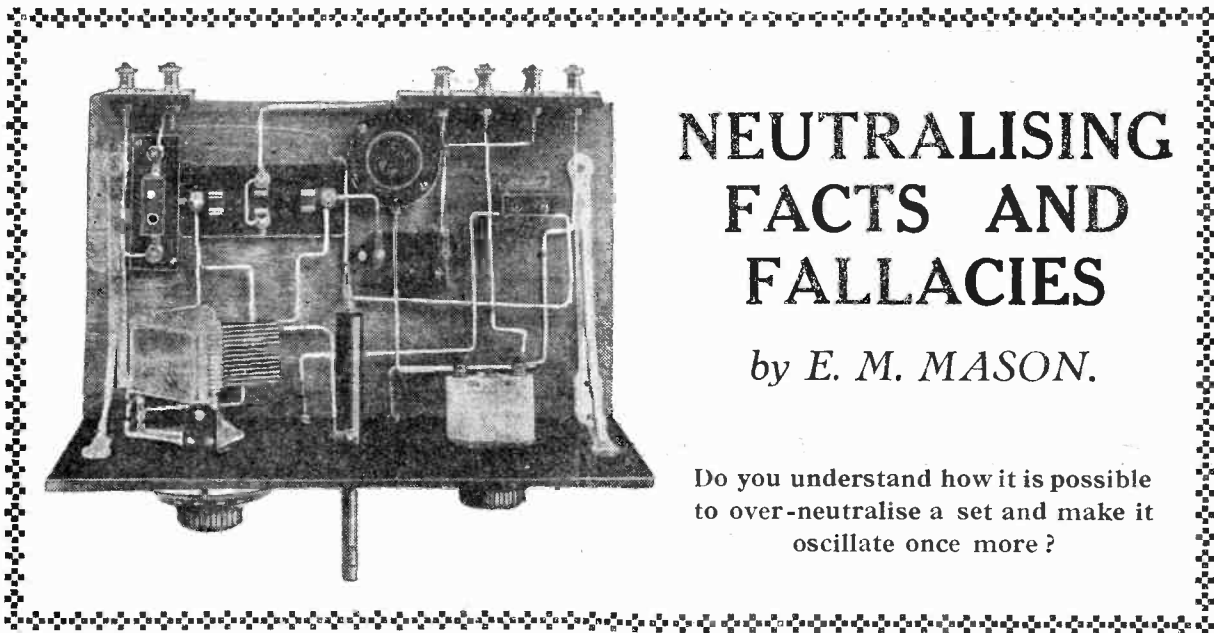

NEUTRALISING FACTS AND FALLACIES

by E. M. MASON.

Do you understand how it is possible to over-neutralise a set and make it oscillate once more ?



ALMOST every receiver incorporating high-frequency amplification involves some system of neutralising the valve capacity. There are exceptions to this rule, such as cases where a resistance-wound aperiodic transformer is employed, or some such scheme in which the tendency to oscillate is controlled by a damping method.

In cases where sharpness of tuning and selectivity are required, however, it is essential to reduce all resistance in the circuit to the minimum consistent with adequate quality, and consequently in such circuits the tendency to oscillate is very marked. Some scheme has to be adopted, therefore, to avoid the inherent reaction produced by the valve, and one of the familiar forms of neutralising is usually utilised for this purpose.

Problems of Operation

Despite the fact, however, that this type of circuit has become so common, there are many points on which there seems to be a certain lack of information. Questions involving the exact operation of neutralising condensers are often evaded rather than definitely answered. For example, consider the circuit shown in Fig. 1. This is just a skeleton split-coil circuit such as is very commonly employed. Where two or more such stages are utilised, it is necessary to take special precautions to avoid the production of parasitic oscillations, but this subject has already been dealt with on various occasions, and it is not necessary to discuss the point further in the present article.

Capacity Feed-Back

With the circuit shown there is a certain tendency for energy to be sent back from anode to grid of the valve through the inter-electrode capacity, and this causes voltages to be produced across the grid and filament of the valve. In certain circumstances the voltages produced by this capacity feed-back are such as to produce a reaction effect, and to increase the signals already existing. If the feed-back is greater than a certain amount, then continuous oscillation will set in, and this is the state of affairs which obtains in an ordinary high-frequency amplifier.

Balancing Out

To avoid this an additional counter feed-back is obtained by connecting a small condenser from the anode of the valve to the remote end of the tuned circuit. This will permit current to flow from the bottom end of the coil up towards the centre tap, which is obviously in the opposite direction to the current produced by the valve feed-back itself. Consequently if the value of the small condenser C_2 is suitably adjusted, the valve feed-back and the counter feed-back can be made to neutralise each other and a stable condition of affairs is obtained.

A Problem

If this neutralising condenser is not large enough then oscillation will still take place. On the other hand, it is generally known that if the condenser is increased beyond the balancing point, oscillation will still take place. Why should this be so ?

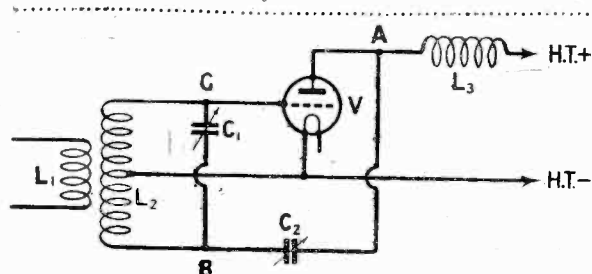

Fig. 1.—In this explanatory circuit the neutralising effect is obtained by means of the small condenser C_2 .

NEUTRALISING FACTS AND FALLACIES—(Continued)

This is an interesting problem, and the solution throws considerable light upon the action of modern circuits. Obviously as we increase the value of the neutralising condenser, so we increase the counter-reaction effect which tends to oppose the positive reaction which is supplied by the inter-electrode capacity of the valve.

A Paradox

At first sight it would appear that any increase in this counter-reaction beyond the correct neutralising point could only serve to damp out the oscillation and to reduce the signal strength. In practice we know that the reverse is the case, and that the signal strength tends to increase again, and ultimately oscillation sets in. It looks, therefore, as if we were making the valve oscillate backwards.

An Extreme Case

Let us consider, however, what happens if the neutralising condenser is made really large. In such cases the condenser behaves practically as a short circuit to the high-frequency current, and its function becomes that of keeping the high-tension from short circuiting through the bottom half of the coil. Those readers who have any experience of transmitting circuits will appreciate at once that the circuit tends to become simply a form of direct-coupled or Hartley oscillating circuit.

Relative to the filament of the valve the two ends of the coil L_2 are at opposite potentials. In a

to prevent the high-tension from shorting, and will not exercise any other effect, provided its value is large.

Now as we reduce the value of the condenser C_2 , so there will be a certain voltage drop across it, i.e., it will act less like a short circuit than formerly, and the points A and B will not be at the same potential. The extreme case is reached when the condenser is removed altogether, or is made very small, when the circuit will cease to oscillate, at any rate in this manner.

A Different Action

It should be noted that the method of oscillation we have just considered does not depend

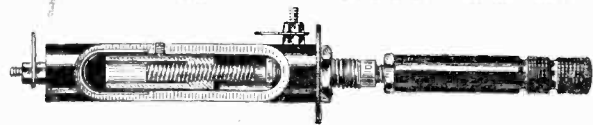

A neutralising condenser should be capable of extremely small variations in value.

for its action upon any feed-back through the valve. In fact, it can easily be shown that the conditions are such that the feed-back through the valve is insufficient to cause oscillation, and, moreover, is not in the right direction.

This second mode of oscillation, therefore, is entirely due to direct coupling between the points B and A, through the condenser C_2 which must be therefore above a certain critical value before the oscillation is produced.

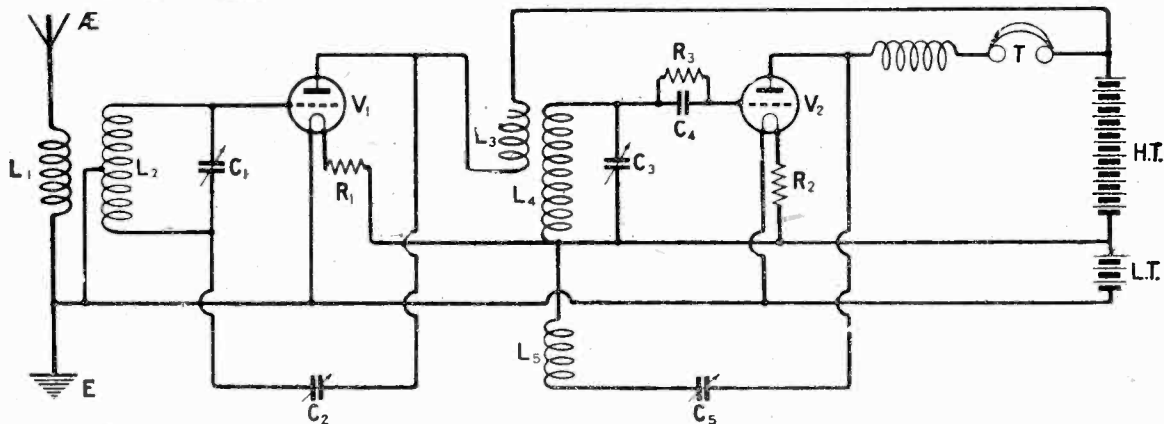

Fig. 2.—A simple two-valve circuit in which the first valve is neutralised, reaction on the second grid circuit L_1C_3 being controlled by the condenser C_2 .

valve which is oscillating, the grid and the anode are also at opposite potentials at any instant. Consequently, if we connect the point B and the anode of the valve we shall be in a position to maintain oscillations continuously, due to an actual direct coupling between two points of approximately equal potential. As we have just stated, the effect of the condenser will simply be

Two Oscillations

On the other hand, if this condenser is removed altogether, then we obtain the oscillation of the first type, due to the feed-back through the valve itself. It will be seen that we really have two definite and distinct types of oscillations, and the

(Concluded on page 230)

PHENOMENAL SUCCESS OF "ELSTREE SIX"

HUNDREDS HEAR THE RECEIVER FOR THEMSELVES FURTHER NOTES AND TIPS ON OPERATION

The phenomenal success of the "Elstree Six" is the one topic of interest in wireless circles to-day. At the time of going to press with our last issue it was too soon to give any definite indication as to the extent of the interest which has been aroused, but it is now possible to say that no receiver before, since the famous S.T. 100, has excited such widespread interest.

The applications for blue prints came in thick and fast, and the specified five hundred was quickly reached. Many of the first five hundred applicants have already been entertained at Elstree, and have heard the receiver in operating conditions. The demand for blue prints, however, did not stop at the five hundred limit, and in fact the demand has not yet given any sign of ceasing.

Parties of 25 at a time are being shown the receiver at Elstree on two evenings each week, and appreciation is expressed on all sides at the remarkable range and selectivity of the receiver. On another page we give the names and towns of a number of readers who have already attended the demonstrations.

The receiver is tuned in on these occasions to several B.B.C. stations showing the daylight ranges which can be achieved, and is also given a rapid test showing how quickly the receiver can be tuned in to the various stations. Questions concerning details of operation are put by members of the audience, and these are answered from time to time as they occur. After the formal portion of the demonstration, the readers handle the set for themselves, and one and all express delight at the wonderful simplicity of the operation.

The question of quality is one which occupies a very important position to-day, so that a few remarks on the subject of how to obtain the best quality may not be out of place. The high-tension voltages used on this receiver are 120 volts on H.T.I., which is applied to the high frequency and low-frequency valves, and 60 volts on the detector valve. These values of voltage were chosen as being convenient for the majority of readers, and also because it enabled the number of high-tension tapings to be reduced.

An Unreasonable Expectation

It is obviously unreasonable to expect a receiver with all six valves amplifying to their fullest extent to give good quality on the local

station at a distance of a few miles only. The volume of the signals applied to the loud-speaker is much too great, and if this had been the object of the receiver a different design for the low-frequency side would have been adopted. With

the voltages specified, adequate and good loud-speaker quality can be obtained on five valves only from the nearer stations.

Special Valves

With the more distant stations the whole six valves will be required, but even so the volume applied to the loud-speaker may prove to be somewhat large. If this is found to be the case, a special low impedance valve should be used in the last stage. Such a valve as the D. E. 5A. having an impedance of 3,500 ohms and an amplification ratio of 3.5 is a suitable valve, but the choice of this valve depends to some extent upon the loud-speaker in use, and if satisfactory results are obtained with the ordinary

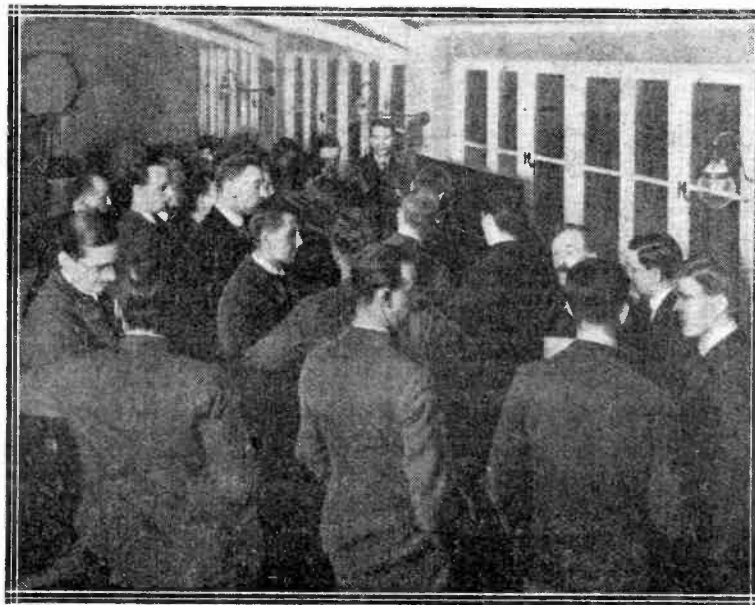

Trying the receiver for themselves. A photograph taken during one of the demonstrations of the "Elstree Six"

MORE ABOUT THE "ELSTREE SIX"

power valve, the reader will probably be advised to continue to use it.

The Rectifier Valve

The rectifier valve is one which has considerable effect upon the quality of the signals. It is often assumed that when anode-bend rectification is being employed, a high-impedance valve should be utilised. While this is correct from the point of view of signal strength, it does not make for good quality.

Volume or Purity

This is because a valve operating as an anode bend rectifier has a very much higher impedance than that at which it is normally rated.

to enable a less efficient rectifying arrangement to be used. A list of suitable rectifier valves is appended.

Suitable Detector Valves

The following valves have all been tried and found suitable.

6 volt.	4 volt.	2 volt.
DE5	PM4	PM2
DFA1		SP18
		red spot
PM6	Cossor point one	
B4	SS7	
SS5		

Different Dials

The demand for components for the "Elstree Six" has been so phenom-

test report is given therefore showing the setting at which the stations can be received using the 0 to 100 dials, and with the aid of this readers will experience no difficulty should they obtain this type of component.

Valves

We have had occasion to try a complete set of the new Mullard P.M. valves. These are at present made in three classes for 2, 4 and 6 volts respectively, each class having two types, one a low impedance power valve and the other a higher impedance type, the impedances being about 6,000 and 17,000 respectively.

DIAL READINGS FOR 0-100 DIVISION TYPE DIALS

Range 1.						
Stettin	50	San Sebastien ..	75½	43	Ecole-Superieure ..	60½
Elberfield	53	Cardiff	77½	44½	Radio-Catalana ..	61
Brussels	55½	Seville		45½	Koenigsberg	61½
Malmö	57	London		46½	Frankfort	62
Cassel	57½	Union-Radio Madrid		47½	Birmingham	63½
Bremen	59	Manchester		48½	Swansea	66
Dortmund	60	Oslo		49½	Lyons	66½
Goteborg	61	Bournemouth		50	Aberdeen	67
Hanover	62	Radio-Iberica		50½	Zurich	69
Barcelona	63½	Hamburg		51	Helsingfors	71
		Dublin		51½	Berlin	73
		Graz		52	Vienna	75
		Newcastle		52½		
Stoke	65 36½	Munster		53½	Hilversum	22
Sheffield	65½ 37	Breslau		54	Hjorring	28
Bradford	66½ 38	Bilbao		54	Karlsborg	33
Dundee	68 38½	Glasgow		55	Daventry	44
Leeds	69 39	Rome		56	Radio-Paris	50
Radio-Barcelona	70 39½	Stockholm		56½	Amsterdam	61
Nottingham	71 40	Radio-Toulouse		57	Soro	70
Edinburgh	71½ 40½	Berne		57½	Eiffel Tower	78
Liverpool	72 40½	Belfast		59	Berlin	89
Petit Parisien	73 74	Stuttgart		59½		
Hull	73½ 42	Leipzig		60		
Plymouth	74 42.5					

Consequently if a high-impedance valve is used, its actual impedance under working conditions may be over 100,000 ohms. In such circumstances the impedance of the transformer primary is nowhere near equal to that of the valve, with the result that the quality suffers considerably.

If on the other hand a low-impedance valve is used, then even allowing for the increase due to working at a highly negative potential, the impedance is not too high, and a satisfactory degree of quality can be obtained. The signal strength is somewhat less with the low-impedance valve, but practical experience shows that there is sufficient reserve of signal strength

menal that many people have had to wait for some time for many of the essential parts. One of the principal difficulties has been that of obtaining dials for the variable condensers, and the problem was still further complicated by the fact that while the original condensers were engraved in degrees from 0 to 180, there are a fair number of dials on the market engraved from 0 to 100, but there appears to be a considerable scarcity of the 0 to 180 type.

In view of the fact that the test report in the original article was given with 0 to 180 degrees condensers, some confusion may have arisen in the cases of the possessors of 0 to 100 dials. An amended

Good Signals

On test we found that the strength using these valves was very good, but that the selectivity was not quite up to standard. The high-impedance type was used for the first three stages, and the low-impedance type for the last three, including the rectifier. The selectivity, however, depends on the use of a very high-impedance valve for the high-frequency stages, and the value of 17,000 ohms appears to be somewhat on the low side.

Messrs. Mullards, however, are bringing out a special high-impedance type of P.M. valve specially for the "Elstree Six" and kindred circuits. With this valve we can

**FURTHER HINTS
AND TIPS ON THE
"ELSTREE SIX"**
(Concluded)

thoroughly recommend the P.M.-series for use in this receiver.

Other Types

We have also tested a complete range of Electron valves. These valves are also made in various types to suit different accumulator voltages, but we have only actually tested the 6-volt type of valve in the "Elstree Six." Three S.S.6 type were used for the high-frequency stages, these valves having an impedance of 27,000 ohms while the S.S.5, a low-impedance power valve, was used for the last three stages.

Excellent results were obtained with these valves, the signal strength and selectivity being quite up to the standard.

Alternative Components

In accordance with our request several manufacturers have supplied us with their pattern of dual condenser, and the following types can be substituted for those specified without detriment to the working of the receiver:—

IGRANIC Dual Condenser.—This is a very robust and well-finished job, and is already fitted with a 4-inch dial.

MESSRS. JACKSON BROS., Dual Condenser.—This is supplied with the usual J.B. finish, and can be used quite satisfactorily. Single hole fixing is provided, but the condenser itself is of a very light construction, and this is not a serious disadvantage.

MESSRS. BOWYER - LOWE Co., Dual Condenser.—Messrs. Bowyer-Lowe have produced a specially strengthened model utilising the principles employed in the well-known "Popular" condenser. The result is an excellent product, and can be recommended for use.

K. RAYMOND, Dual Condenser.—This instrument is a straight-line frequency condenser of very robust and pleasing construction. Single hole fixing is provided, but this should not prove a serious disadvantage as the instrument is comparatively light. The dial readings will, of course, be totally different from those specified in the test report which has been given owing to the different capacity curve given by the straight-line frequency condenser, but readers who prefer this type of instrument will find the condenser useful.

**READERS' IMPRESSIONS
OF THE "ELSTREE SIX"**

"A Fair Test"

SIR,—I was greatly impressed by the "Elstree Six" by its selectivity and simplicity. I alone tuned in six stations in as many minutes.

Around this locality (about 11 miles from 2LO) amateurs have practically given up trying to cut out the interference from that station, but I am certain the "Elstree Six" will solve that problem.

The "Elstree Six" not only separates 2LO from Cardiff but

fill my new pedestal cabinet, so here goes on the "Elstree Six."—
Yours truly,
D. NEILSON.

Kentish Town, N.W. 5.

"A Wonderful Set"

SIR,—I was much impressed by the demonstration of the "Elstree Six." To give an example, I heard Hull on the loud-speaker in the middle of the day, and no 7 or 8 valve set, whether superhet. or not, which I have heard, has ever been able to bring in a distant relay

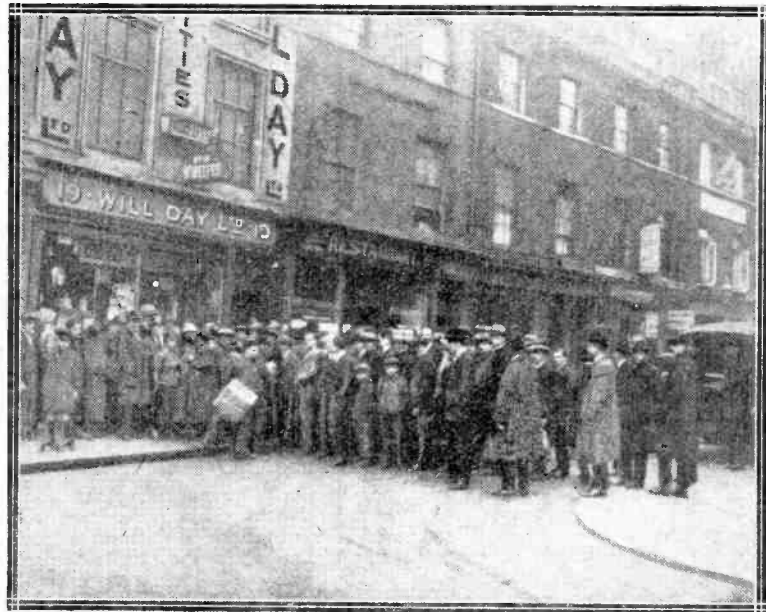

Some idea of the great success of the "Elstree Six" may be gained from this photograph taken outside the premises of a well-known London dealer. The queue are awaiting their turn to see a replica of the receiver which was on view at the time

when listening to Radio-Paris there is absolutely no background from Daventry—that I have never heard before. The tuning-in was simply a process of turning dials to the same number of degrees.

On arriving at Elstree I expected to see an "Eiffel Tower Aerial" and was surprised to find a very moderate one—thus giving a fair test.

I have waited months for a selective and simply tuned set to

in daylight. I consider it a wonderful set.—Yours truly,
Hove.
J. A. MARROT.

Fulfils the Claims

SIR,—I was well pleased with the courteous way in which the demonstration to which I had the pleasure of attending was conducted, and think that the "Elstree Six" fully merits the claims made regarding its capabilities.—Yours truly,
Enfield.
H. E. BLAXILL.

The "SCREENED-COIL THREE"

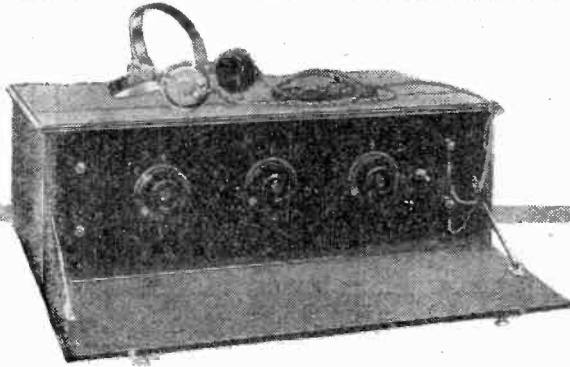

By J. H. Reyner,
B.Sc. (Hons.), A.M.I.E.E.

A selective long-distance receiver utilising the latest development of H.F. amplification.



THE advantages of screened coils are rapidly becoming appreciated owing to the increased selectivity and stability that can be obtained by their use. The set described in this article utilises a simple and popular form of circuit, the tuning coils, however, being enclosed in suitable screening cases.

Direct Pick-up

In consequence, the interaction between the high-frequency-circuits is definitely eliminated, so that absolute stability is obtained, while the presence of the screening also eliminates any direct pick up on the coils themselves which materially improves the selectivity where the set has to be operated fairly close to a broadcasting station.

Actually the selectivity is of a high order, it being possible to

receive both Manchester and Cardiff at Elstree when London is working. In the test report, given later, details are given showing the performance of the set both at Elstree and nearer to 2LO.

The Circuit

The circuit adopted is of a simple and straightforward character, and is illustrated in Fig. 1. The aerial is connected to the first tuned circuit by the usual auto-coupled arrange-

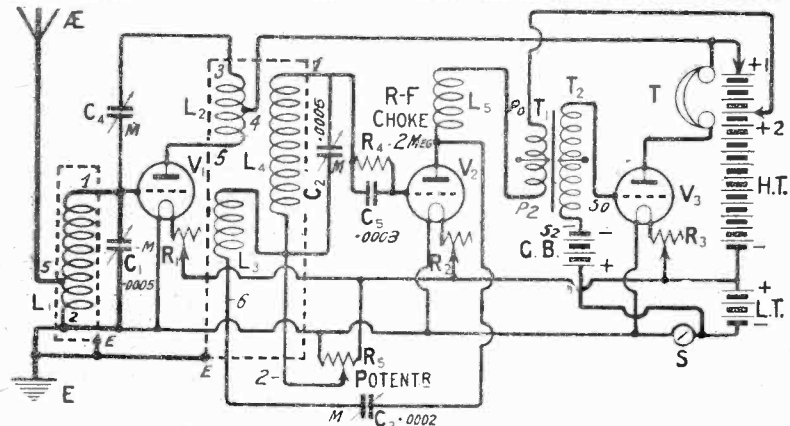
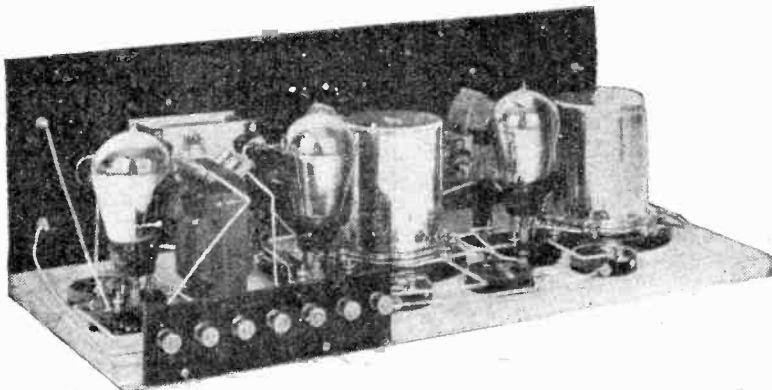

Fig. 1.—The grid potential of the rectifier valve is controlled by a potentiometer.



The screened coils can be seen very well in this view.

ment, tapings being taken on the coil at four different points. The high-frequency valve is coupled to the second (detector) valve by a transformer coupling, the split primary method of neutralising being adopted. Details of the actual transformers and coils are given later in the article.

The Rectifier

Grid condenser rectification is employed in this case, but the grid potential is made variable by means of a potentiometer. With the modern valve it is necessary to connect the grid leak to a point at a slightly positive potential. This has

THE "SCREENED-COIL THREE"—(Continued)

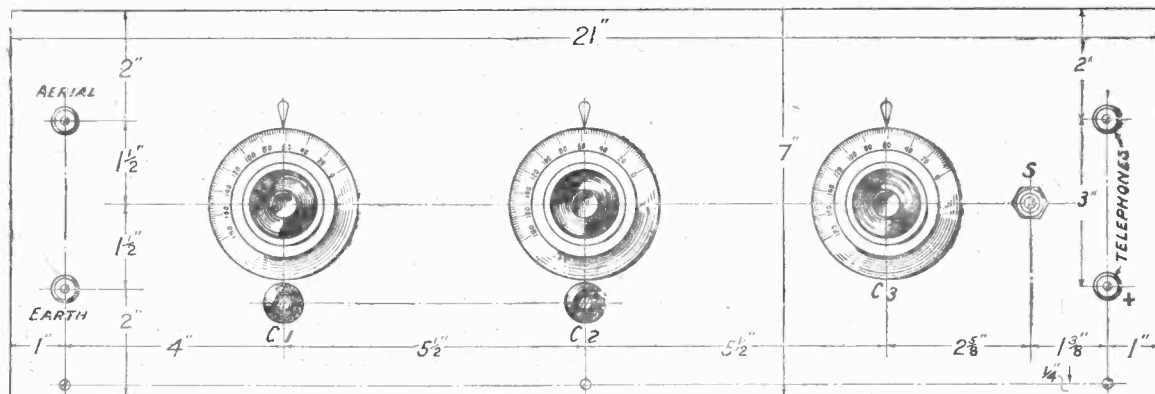

Fig. 2.—The panel layout is given in this figure. Blue print No. 172a may be obtained on application free of charge

led to the conventional use of the grid leak connected through L.T. + In the majority of cases, however, this is rather more than is necessary, and introduces extra damping into the tuning circuit connected across the grid and filament of the rectifier valve.

Potentiometer Control

If, on the other hand, the grid leak is connected to the negative of the filament, the selectivity is materially improved, but the signal strength is not quite as large as with the other arrangement, owing to the less efficient rectification obtained. In the present instance, therefore, a potentiometer has been incorporated, connected across the low-tension battery, so that the best polarising potential on the grid leak can readily be obtained according to the particular valve in use, and a point can then be obtained at

which the selectivity and signal strength are both satisfactory

Reaction Control

A Reinartz type of reaction is provided on the rectifier valve, and

action is possible, and this materially assists the range of the receiver.

Non-Radiating

Incidentally, since the first valve in this receiver is correctly neu-

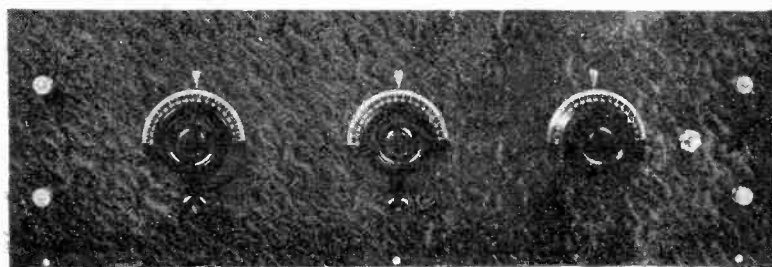

The Trolite panel gives a distinctive finish.

the smooth control of the oscillation will also be found to depend to some extent upon the position of the potentiometer. It is easy to obtain a point at which very smooth re-

tralisied, the receiver is non-radiating, and reaction may be used on the second valve with impunity. This is of material interest in the handling of the set because the same precautions to avoid oscillation have not to be observed as is the case with a radiating receiver.

Actually in the particular receiver described the reaction adjustment remains fairly constant over the whole range and only requires minor alterations from time to time.

Filament Resistance

A new type of resistance has been employed in the filament circuits in this instance. There are some people who do not like a fixed resistor because it definitely limits one to a particular class of valve. At the same time the filament control of the modern valve is not a matter of constant adjustment, and once the correct point has been

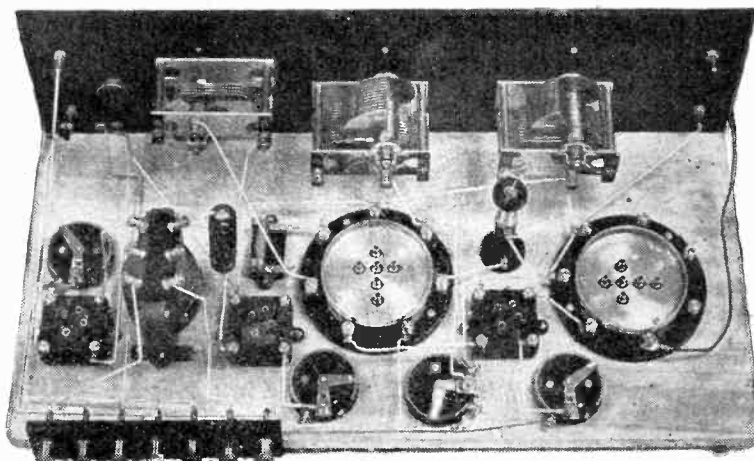

Note the baseboard-mounting, filament resistances and potentiometer.

A SENSITIVE SCREENED-COIL RECEIVER

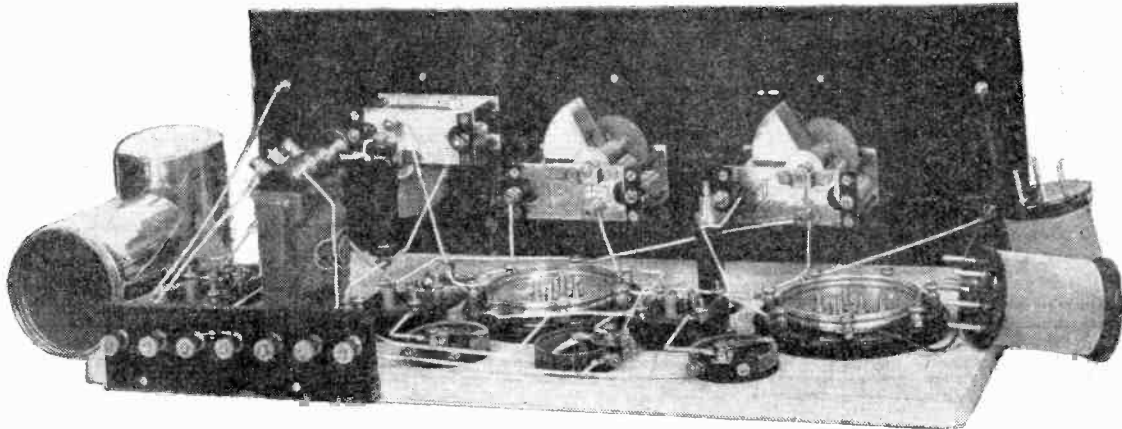

This view shows the layout with the screens removed. The coils themselves may be seen on the right.

obtained the filament circuit is not varied in practice.

There is, therefore, no necessity for this adjustment to be a panel-mounting one, and Messrs. Lissen have produced a model of their standard resistance which is designed for baseboard mounting. The resistance may then be adjusted to suit the valves in use, after which it can be left and not altered in practice.

This type of resistance is extremely convenient, giving a very flexible arrangement, and the potentiometer which is incorporated on the grid leak has also been made of this type, so that all these controls are taken off the panel.

The Panel Lay-out

The actual controls on the panel therefore are simply the two tuning

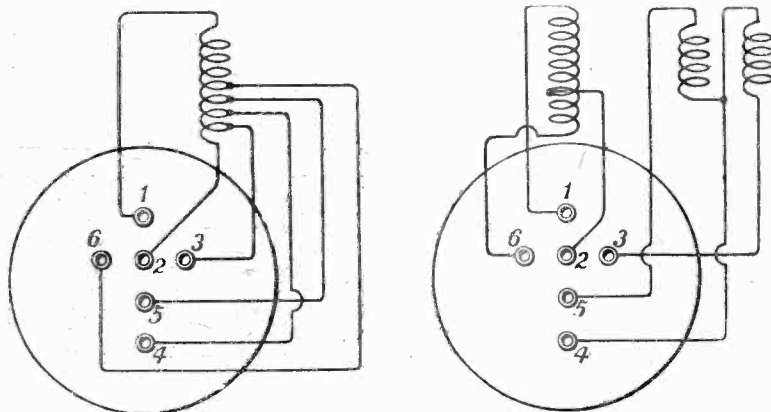

AERIAL COIL

H.F. TRANS

Fig. 3.—This diagram indicates the connections to the coils as seen looking down on them.

WIRING INSTRUCTIONS

Join Earth to No. 2 connection of L1. No. 2 connection of L1 to moving plates of C1. Moving plates of C1 to E of 2nd screened coil. E of 2nd screened coil to F— of V2. F— of V2 to one side of S; same side of S to F— of V3. Also join No. 2 connection of L1 to E of 1st screened coil. E of 1st screened coil to F— of V1. F— of V1 to — of R5.

Join one side of R1 to + of R5. + of R5. to one side of R2; same side of R2 to H.T.—. H.T.— to L.T.+; L.T.+ to one side of R3. Join other side of R3 to F+ of V3. Join remaining side of R2 to F+

of V2. Join remaining side of R1 to F+ of V1. Join fixed plates of C1 to moving plates of C4; moving plates of C4 to G of V1; G of V1 to No. 1 connection of L1.

Join moving plates of C2 to No. 2 connection of L3; No. 2 connection of L3 to moving arm of R5.

Join fixed plates of C2 to No. 1 connection of L4, thence to one side of C5 and R4.

Join fixed plates of C3 to one side of C5, thence to A of V2.

Join moving plates of C3 to No. 6 connection of L3.

Join fixed plates of C4 to No. 3 connection of L2.

Join No. 4 connection of 2nd screened coil to H.T. + 1, thence to telephone + terminal.

Join No. 5 connection of L2 to A of V1.

Join remaining side of C5 and R4 to G of V2.

Join remaining side of L5 to P2. Join P.O. to H.T. + 2.

Join remaining side of S to L.T.—, thence to G B +.

Join S O to G of V3.

Join S2 to G B—.

Join A of V3 to remaining telephone terminal.

Join flex lead with spade tag for tap on L1 to aerial.

THE "SCREENED-COIL THREE"—(Continued)

condensers, the reaction condenser and the on and off switch. The Aerial, Earth and Telephone terminals have been placed on the panel as well, all the other terminals being placed at the back of the set.

A Trolite panel has been employed, which has an attractive finish, so that the whole set is of particularly pleasing appearance.

There is no hand effect on the operation, and no difficulty will be experienced with a plain condenser.

On the other hand the reaction control on this receiver can be made so fine and sensitive that a geared condenser may be employed if any reader so desires. Ample space has been left for a similar condenser

given as a guide for those who wish to make up a duplicate of the set. Similar components of high quality may be used if desired provided that the values are as specified below. The actual components are:—

One panel, 21 in. by 7 in. by 1/4 in. (Trolite).

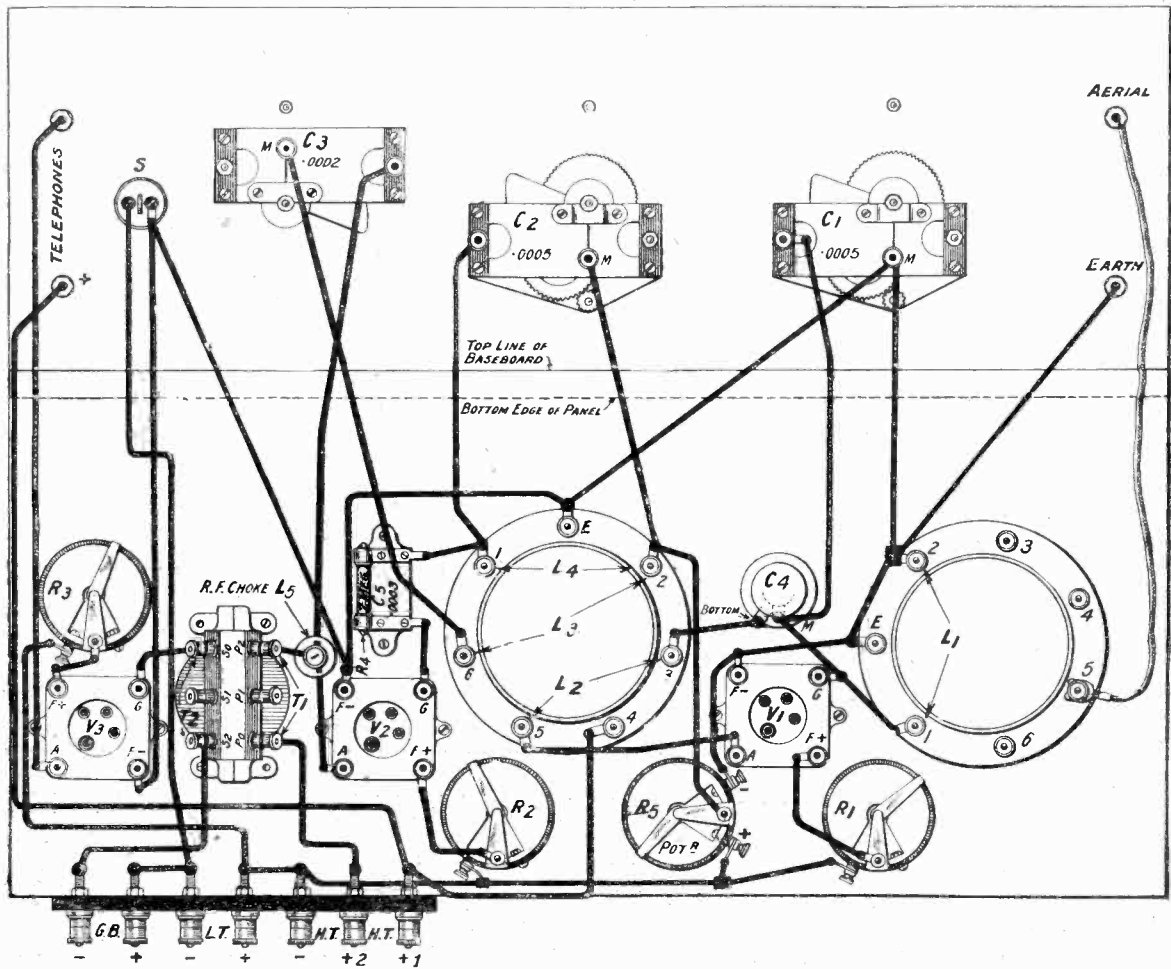

Fig. 4.—The layout of the components and the wiring diagram. Blue Print No. 172b can be obtained, if desired, in accordance with our free Blue Print scheme.

The Condensers

Geared condensers have been employed because the tuning is of necessity sharp, and some form of slow motion is essential for satisfactory results.

A geared condenser has not been employed for the reaction control, because a simple condenser was found reasonably satisfactory.

to the tuning condensers, so that should any reader feel inclined to utilise a geared condenser for the reaction he can do so without difficulty.

Components

The components that are required are as listed below. The manufacturers' names have been

One cabinet to suit with base-board 9 in. deep (Camco).

Two .0005 variable condensers, slow motion type (Jackson Bros.).

One .0003 variable condenser (Jackson Bros.).

Two coil screens (Bowyer Lowe 30/- Co.).

One aerial coil (Bowyer Lowe 10/- Co.).

A SENSITIVE SCREENED-COIL RECEIVER

15/- One high-frequency transformer, split primary type, with reaction coil (Bowyer Lowe Co.).

7/6 Three 6 ohm baseboard mounting resistances (Lissen, Ltd.).

7/6 Three vibratory valve-holders (Etherplus).

5/- One baseboard mounting potentiometer, high-resistance type (Lissen, Ltd.).

3/- One neutralising condenser (L. McMichael, Ltd.).

1/6 One multi-ratio low-frequency transformer (R. I., Ltd.).

2/- One on-off switch (R. A. Rothermel, Ltd.).

2/6 One .0003 fixed condenser with 2 megohm leak (Dubilier Co.).

10/6 One H.F. choke (Metropolitan Vickers).

Four terminals.

One terminal strip carrying 7 terminals.

Three "Decko" dial indicators (A. F. Bulgin and Co.).

Constructive Details

The actual construction of the set will present little difficulty. First mark out the panel in accordance with the diagram given, and then mount the three variable condensers, the two terminals, and the on-off switch in the positions shown.

The baseboard components

will be seen that one is in a slightly different position from the other.

The Wiring

When the components have been laid out, the panel may be fixed in position straight away, and the

to wind their own, but the coil and transformers required for the set can be purchased with the screens if desired.

The Aerial Coil

The aerial coil is the simpler

TEST REPORT.

C ₁	C ₂	Station.	Remarks.
67..	90..	Nuremberg	
68..	94..	Radio Iberica	
71..	96..	Cardiff ..	Interference by London
75..	100..	London	
79..	104..	Manchester	
81..	108..	Bournemouth	
84..	110..	Munster	
86..	115..	Dublin	
90..	118..	Newcastle	
96..	125..	Rome	
100..	130..	Glasgow	
104..	134..	Belfast	
110..	143..	Frankfurt	
112..	146..	Birmingham	
114..	148..	Swansea	
117..	151..	Aberdeen	

wiring completed in accordance with the wiring diagram provided. Little difficulty will be experienced with the wiring, which is very simple and direct. Care must be taken to ensure that all the terminals are screwed up tight after the

and consists of 90 turns of 30 D.S.C. wire spaced 40 turns to the inch. Actually this is best accomplished by utilising a grooved former to wind the turns on, but if this is not available, some other method of spacing may be adopted.

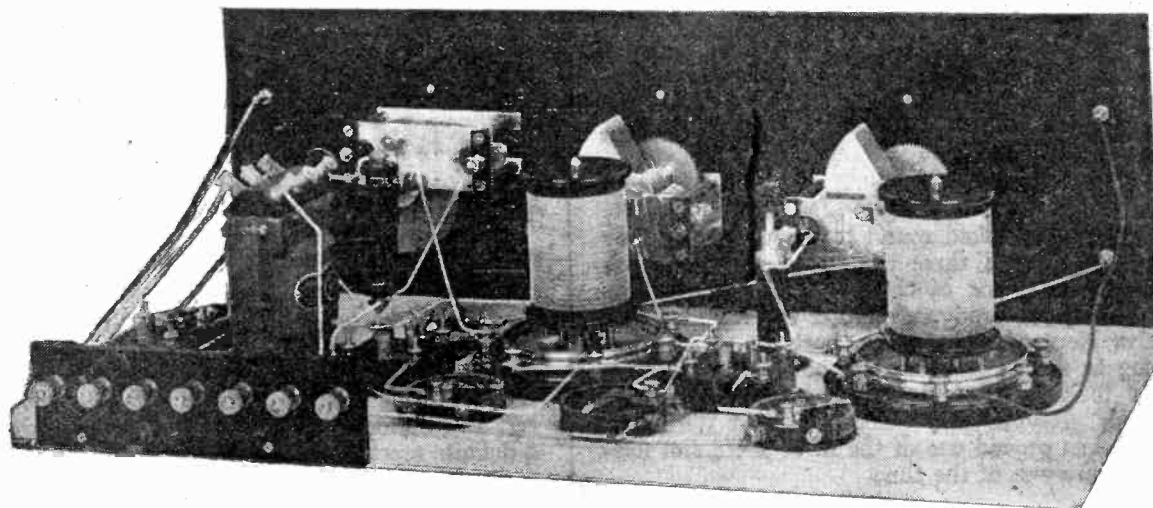

The coils are shown here in position with the screens removed.

should be mounted next, and little difficulty will be experienced here if the wiring diagram is followed carefully. The layout of the two screened coils should be noted as it

soldering is completed in order that good contact will result. The receiver is now ready for winding the coils. Details of the coils are given for those who prefer

Tappings are taken on this coil at 5, 8, 12 and 15 turns, and the connections to the coil are brought out to the terminals as shown in fig. 3. (Continued on page 287.)

ELSTREE'S FAME EXTENDS

Night Raiders Pay Elstree Surprise Visit

ATTEMPTS TO STEAL "ELSTREE SIX" FOILED

Much Valuable Apparatus Stolen

WE have had many visitors to our Elstree Laboratories, including some famous men, and it is one of our pleasantest duties to show them the equipment and developments which are constantly being carried out. We recently received, however, a surprise call from less welcome visitors to whom the fame of our laboratories had apparently extended. The thieves awaited their opportunity one evening until the staff had finished their normal duties at about midnight (most of the testing work, of course, being carried out during the evening) and then broke into the laboratories and stole a quantity of valuable apparatus.

The Main Object

There can be little doubt that their primary object was the "Elstree Six" itself, which has, by now, become one of the world's classic receivers. Fortunately, however, they were foiled in their attempt, because this receiver, used as it is for demonstrations to a large number of interested people, had been installed as a permanent fixture. The thieves, therefore, decided that the risk of detection involved by completely dismantling the equipment was too great, and they contented themselves with removing the valves and a large quantity of coils.

The Booty

They then looked round to see what else they could steal, and three completed receivers took their fancy. One of these was an Igranic Six-Valve Superheterodyne, another was a Fada Five-Valve Neutrodyne receiver, both these receivers being in for examination by our staff. Thirdly, they took the "Magic Five" receiver, designed by Mr. Reynor and published in "Wireless," which has proved one of the most successful five-valve receivers of the time.

Accessories

They then helped themselves to a large quantity of valves, instruments and minor accessories, and carted the whole away in a van of some sort. Their haste was evident by the fact that portions of loud-speakers, partially made sets, and such like were found scattered along the road at intervals. So far no trace of the thieves has been brought to

light, but the police have several important clues which are being followed up.

The Wavemeter

The fortunate part is that the famous wavemeter which is so valuable in a large number of experiments was left undamaged. It is not so much the actual cost of this wavemeter as the time which has been spent in developing it to its present state of perfection, rendering it one of the finest in the country, which makes it so extremely valuable.

New Designs

At the same time there were several experimental receivers containing new designs for the coming season, which of course were of a highly confidential character. Probably the apparent crudeness of these experimental models misled the marauders, who did not appreciate their full significance, or otherwise the consequences might have been more serious.

NEUTRALISING FACTS AND FALLACIES (Concluded from page 221)

circuit changes over from one to the other as the value of the condenser C_2 is increased.

Reaction Effects

Reaction is often obtained in high-frequency amplifiers by connecting up a symmetrical neutralised circuit such as that shown in the figure, and increasing the neutralising condenser beyond the balancing point. While this does give a certain reaction, it is not as smooth or effective as a definite reaction applied by other means.

A Better Method

It is better, if possible, to apply a definite reaction by means of one of the recognised methods. The circuit shown in Fig. 2 is one such arrangement, a simple Reinartz type of reaction being employed. The circuit $L_5 C_5$ is connected across the anode and filament of the valve, and as the value of the condenser at C_5 is increased so the reaction effect increases.

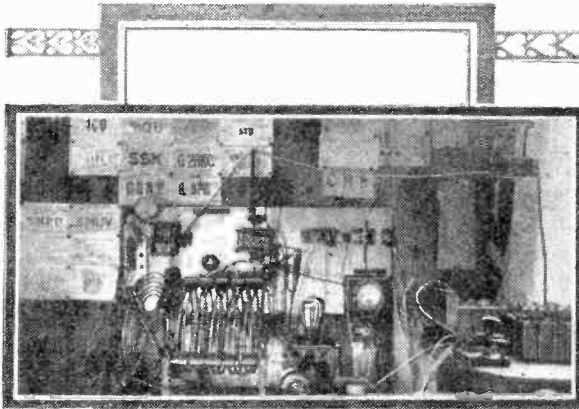

SHORT-WAVE TRANSMISSION UNDER DIFFICULTIES

By A.V.D. HORT, B.A.(5HU)

Some experimenters may be discouraged from taking up transmission by adverse local conditions. In this article the author tells how good results have been obtained at his station, in spite of the fact that conditions are far from ideal and only very low power has been used.

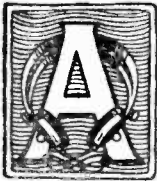

FTER some months' experience of reception on short waves, for which purpose an indoor aerial was usually found quite adequate, the writer of the present article wished to extend his activities to transmission. Since only low power was to be used, the problem of the transmitter itself presented no particular difficulties, the receiving components being equally applicable to a low-power transmitter.

The real difficulty which was encountered was that of erecting a suitable aerial system. An indoor aerial consisting of a flexible cable stretched across two rooms was satisfactory enough for reception, but it was not to be expected that any great distance could be covered in transmission with its aid, especially as 45 metres was to be the wavelength employed.

Poor Surroundings

A study of the diagram of Fig. 1 will show the situation of the transmitter and its immediate surroundings. It will be seen that the transmitter is in the front room of the house. The window close to it looks out on the street, a tree of medium size occupying a large part of the small piece of garden in front. On first considering the question of an outside aerial, it was thought desirable to locate it in this front garden in some way, in order to bring the lead-in through the con-

veniently placed window. Two possible methods of erecting the aerial here were considered, the first of these being to place a mast in the tree and run a wire straight up from the window to the top of it. This, however, would have provided only a short aerial, and the wire would have had to be taken somewhat close to the projecting

Aerial Difficulties

The alternative method at the front of the house was to take a wire up the wall of the house itself, supporting it and holding it out from the wall by insulators at fairly close intervals attached to the ends of wooden pegs themselves fixed in the wall. This, again, would

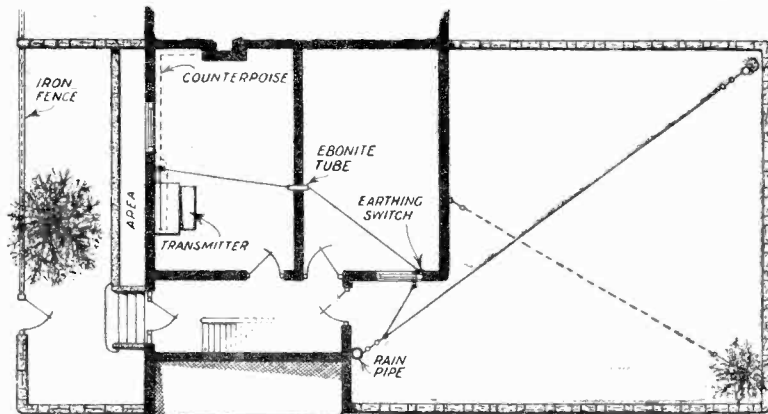
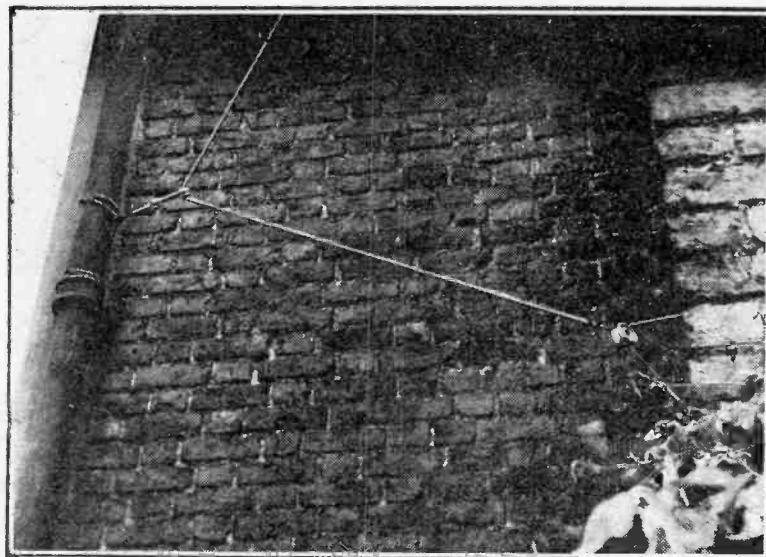

Fig. 1.—In this ground plan of the house and garden described, the author's aerial is shown by the full line and the crystal set aerial by the dotted lines.

branches of the tree. This might not have mattered in the winter, but now that the tree is in full leaf considerable losses would no doubt occur if this arrangement had been adopted. The proximity of the iron fence along the front of the garden had also to be taken into account as a probable cause of losses.

not have given any great length to the aerial, though this difficulty might have been overcome. The intention, in fact, was to erect an aerial somewhat similar to that used at KDKA, the station at East Pittsburgh, in America, well known for its short-wave transmissions, the aerial in that case being supported on a vertical mast.



In this view of the leading-in point the insulator holding the aerial clear of the window frame is to be seen on the right.

This proposal was definitely ruled out by the fact that the brickwork of the wall is covered over with a layer of plaster, which is by no means secure. A close examination of this plaster left little doubt that even if only a few nails were driven into it the whole surface of the wall would fall away. This was a prospect that the writer did not feel prepared to risk!

An Alternative Arrangement

It remained, then, to erect the aerial at the back of the house. This, in fact, was much to be desired, since the garden at the back provides ample space for an aerial of quite reasonable dimensions. The problem to be surmounted was that of taking a lead from the transmitter to this garden. It might be thought that the easiest way out of the difficulty would have been to have moved the transmitter itself into the back room, and so had simply a short lead-in through the window. Unfortunately this course was impossible, partly owing to reasons connected with the lighting of the two rooms, and also for domestic reasons to do with furniture and such matters.

The Lead-In

It was decided that the indoor part of the aerial must be kept as far as possible from the walls and ceilings, in order to reduce losses. No very high efficiency was expected anyway, but every effort was made to give the transmitter a

reasonable chance to do good work. As will be apparent from the photographs of the transmitter, the aerial lead starts at the left-hand end of the table, the hot-wire ammeter and series condenser being visible at the top of the table at this end.

The lead is carried over the top of the table to the change-over switch which connects the aerial to either the transmitter or the receiver at

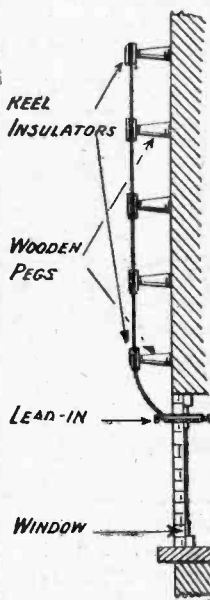

insulator immediately above it a copper ribbon, $\frac{1}{4}$ in. wide and $\frac{1}{16}$ in. thick, passes straight upwards to another insulator about 3 feet higher and 15 to 18 inches below the ceiling.

Copper Ribbon

It may be mentioned here that the whole of the indoor portion of

SHORT-WAVE TRANSMISSION UNDER DIFFICULTIES (Continued)

the aerial is composed of the copper ribbon described above. This is, of course, not really necessary for transmission on 45 metres, but as it may be disconnected from the outside portion of the aerial, it is hoped that it may prove of use for transmission on 23 metres at a later date. The lead which is visible in one of the photographs passing diagonally across the front of the transmitter is that from the change-over switch to the receiver.

Continuing with the aerial, from the upper insulator on the wall above the switch the aerial passes at right-angles across the room and through the wall into the next room. This wall is about 8 inches thick, but fortunately is not very solid, being a partition wall of wood and plaster. An ordinary ebonite lead-in tube, $\frac{1}{2}$ in. in diameter, carries the ribbon through the wall. This is probably the worst point of the indoor part of the aerial, but it was impossible to make a larger hole in order to allow more clearance round the ribbon. From the other side of the wall the ribbon goes direct to the window.

Safety Arrangements

At the top of the window-frame is fixed a single-pole change-over switch. To the centre of this is connected the outside aerial, which is $7/22$ stranded wire of the ordinary type. The copper ribbon is connected to one of the side contacts, while from the other a lead of $7/22$ wire is taken down to a mass of buried metal. This earth is not used in conjunction with either the transmitter or the receiver, and is merely a safety earth for earthing the outside portion of the aerial when it is not in use or when thunderstorms are in the vicinity. When the outside aerial is earthed, the indoor portion may be used separately for reception.

A Rival Aerial

The dotted line passing diagonally across the garden in Fig. 1 represents the aerial of a crystal set which is used on the basement floor

Does your aerial seem hopeless for transmission? It is quite worth while to give it a practical trial. That appearances may be no guide to results is amply demonstrated in this article.

of the house. Its average height above the ground is about 8 feet. Owing to the presence of this aerial, it was considered undesirable to erect a mast for the transmitting aerial in such a position that the two would run anywhere nearly parallel.

On the other hand, the disadvantage of having to put the mast in the other corner of the garden, where it is in fact situated, will be apparent from Fig. 1. The angle of the house at the leading-in point makes for an awkward kink in the aerial. The proposal to put up a mast a few feet out from this window and a short distance towards the other end of the garden was vetoed owing to the rights of

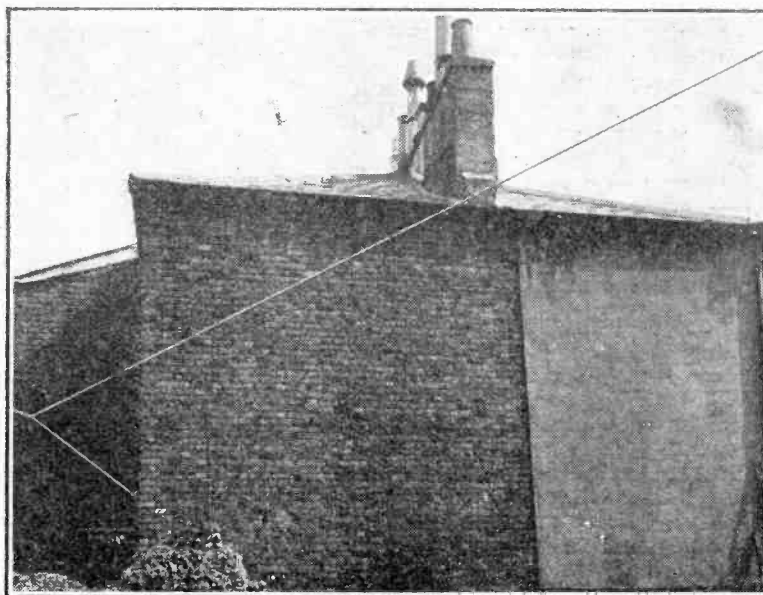

A clear run is obtained for the aerial from the house to the mast, though the wire is well below the level of the former.

The Only Method

The result of this is that the outside part of the aerial rises

order that the wire shall not foul the projecting part of the wall above the window-frame, a single insulator attached by a cord to the wall below this point serves to hold the wire down. These details are clearly shown in one of the photographs.

From the insulators on the rain-pipe all is plain sailing. The wire runs diagonally across the garden, passing over the top of the crystal set aerial, and terminates on a mast lashed to the stump of a tree in the far corner. At present, since this mast is not tall, the average height of the whole aerial, including the indoor portion, is in the neighbourhood of 10 feet, the length being 80 feet from the transmitter to the mast.

Little Interaction

In one of the photographs the aerial appears to be considerably higher above the ground than it actually is, owing to the effects of perspective when the wire is looked at from below. Actually it crosses the aerial of the crystal set with about 3 feet separating the two aerials. Hardly any interference is noticed by the owner of the crystal set if the transmitter is operated during broadcasting hours, a faint clicking being the only effect observed. On the other hand, any readjustment of the crystal is liable to upset the tuning of the short-wave receiver, while the best results are obtained with the transmitter when the crystal set aerial is earthed and the set is out of use.

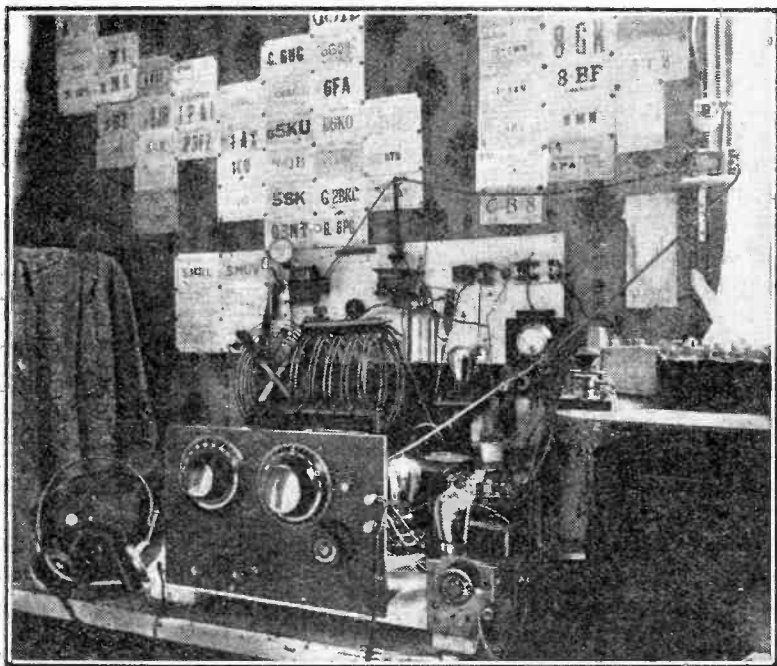

The change over-switch is to be seen on the right, the flexible lead to the transmitter being carried on an insulating post above the back of the table.

the tenants of the rooms overhead, whence a window faces in the same direction. The presence of the aerial alone was not objected to.

sharply from the top of the window and is secured through the medium of two insulators in series to a conveniently placed rainpipe. In

SHORT-WAVE TRANSMISSION UNDER DIFFICULTIES (Concluded)

Curious Effects

On one occasion a sudden decrease in signal strength from the transmitter was reported by a station with which communication had been established, and this was found to be due to the fact that at that moment the crystal set was brought into use. It has also been observed that the short-wave harmonics from the London station are much stronger when the crystal set is tuned to this transmission, 2LO's aerial being only about $1\frac{1}{2}$ miles distant.

The "Earth" System

Various types of "earth" connection were tried with the transmitter, and the arrangement eventually adopted and now in use consists of a short counterpoise. A 10 ft. length of heavy rubber-covered flexible cable runs from the left-hand end of the transmitter table round the room to the fireplace, secured by means of staples in the angle between the wall and the floor. A longer wire than this proved unsatisfactory, and in fact it would be a difficult matter to accommodate it in the room owing to the presence of the fireplace on one side and the door on the other.

The experiment of taking a long lead out into the garden and under the aerial in the conventional manner increased the capacity of the aerial system and also the indicated aerial current without any apparent useful increase in efficiency. For the receiver an ordinary direct earth connection is provided, the use of the counterpoise for this as well as the transmitter producing too many "dead spots" and leading to undesirable complication in the change-over switching.

The Transmitter

Although this article is primarily intended to describe the aerial system and some of the results which have been obtained with it, or perhaps in spite of it, there are one or two points in the transmitter itself which may be of interest.

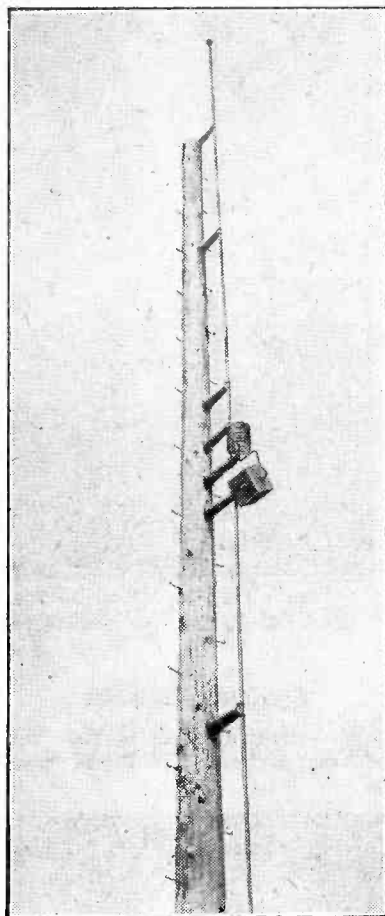

This photograph of one of the aerals used at KDKA for short-wave transmission may be compared with the diagram Fig. 2.

The power used as the input to the transmitting valve, which is a D.E.5, has not yet exceeded 3.6 watts, the high-tension supply consisting of wet and dry primary cells, about 150 volts being provided. In view of this low input power, the aim throughout has been to send out as steady and pure a C.W. note as possible.

Rigidity

To this end the assembly of the transmitter has been designed to be rigid, so as to avoid any unsteadiness of the note such as that caused by vibrating leads or components. The main inductance, as will be seen in the photographs, is of large size. It is built up of five two-turn sections of $\frac{1}{4}$ in. copper rod, clamped together and bolted to both the top and the back of the table. The aerial coil is a six-turn helix, hinged on the back of the table in order to provide a variable coupling with

If you are interested in short-wave reception you will know the value of steady signals. Poor conditions may be compensated for by careful attention to this point.

the main inductance. Once the optimum coupling position had been found, however, this coil was lashed in the correct position to obviate vibration. The principal connections carrying high-frequency currents consist of lengths of the copper ribbon used for the indoor portion of the aerial.

A Steady Note

At first the key was placed on the same table as the transmitter, but it was found that the action of keying produced vibrations which affected the steadiness of the note. A certain amount of weakness in the part of the floor under the table did not tend to improve matters. The key is now mounted on the table on the right, and as an additional safeguard all the leads to the transmitter table are flexible. Slight movements of these leads do not produce nearly such a pronounced effect as that caused by the periodic vibrations of rigid wires.

Results Obtained

To come to the results obtained with the transmitter, work was started in March, 1926, about 3 watts input being the normal. With this power stations were worked in Great Britain, France, Belgium, Italy, Sweden, Germany, and Finland. The best achievement was two-way communication with Madeira on 3.6 watts, signal strength being reported as R6. During subsequent weeks the input was reduced to the neighbourhood of 2 to $2\frac{1}{2}$ watts, with which power communication was established with all the countries already mentioned, and also Poland, Holland, and Denmark. Recently signals were reported R5 in Dunkirk when the input was 1.1 watts.

It is possible that the situation of the writer's station on fairly high ground in North-west London contributes something to the good results obtained. On the other hand, the aerial itself is not high above the ground, the indoor portion being a bare seven feet above the floor.

BALLASTING RESISTORS FOR FILAMENT CONTROL

By the Staff of the Radio Press Laboratories.

A very interesting substitute for the conventional variable filament rheostat is to be found in the "Barretter"—a device which automatically limits the current to a definite value

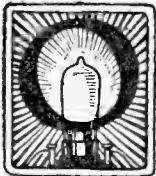

ONE is so accustomed nowadays to the use of a simple variable resistance for the control of the filament current of a valve that alternative methods are hardly ever considered. There has certainly been a tendency recently

towards the use of fixed resistors instead of variable rheostats, a practice which has a good deal to recommend it; but this is after all only an extension of the conventional idea.

Fixed Resistances

In another article in this issue Mr. Harris has discussed the question of fixed resistances, and has shown that this method of control is quite satisfactory with valves operating on an accumulator battery. He effectively lays the ghost of the oft-

was very useful under service conditions and materially lengthened the life of the valves.

A Reappearance

This device has made its appearance on the market once again, and it is therefore of interest to discuss the actual action of these devices. The action is due to an ingenious balancing of two effects, and when this is obtained, the arrangement is known as a ballast resistor. The range of voltage over which the balancing action occurs is usually somewhat limited, and it is a matter of careful design to obtain the conditions which one requires.

Temperature Co-efficient

It is a well known fact that if a current is passed through an ordinary wire a certain amount of heat is generated. Now this heat in the wire will cause

a small variation in the resistance of the wire. In the majority of cases the resistance of the wire increases as the temperature rises. One or two special alloys have been devised, one of them having the peculiar name of Ya-Ya, in which the *temperature co-efficient* of the wire, as it is called, is negative. That is to say, as the temperature rises the resistance of the wire decreases. Several non-metals, the principal being carbon, also possess such a negative temperature co-efficient, but with the majority of metals the resistance of the wire increases as the temperature rises.

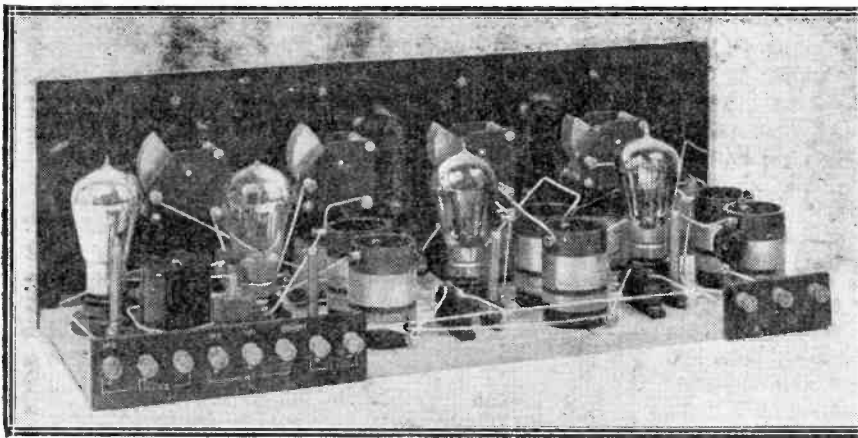

A number of successful set designs have been produced which use automatic controls for the filament current.

quoted objection that the current through the valve will drop as the accumulator runs down by pointing out that when the accumulator begins to drop in voltage it is time it was recharged.

A War Measure

During the war many of the sets captured from the Germans were found to be equipped with special ballasting resistors, or barretters as they were called, in place of the more usual filament control. These devices were made up of a filament of wire in a glass vessel filled with an inert gas, and they had the effect of maintaining the current to the valve appreciably constant over a wide range of voltage. Such an arrangement, of course,

ance of the wire increases as the temperature rises.

A Limiting Effect

Now let us assume that the wire is so fine that the normal current which passes through raises it to an appreciable temperature. Then its resistance will undergo a large change and this will tend to limit the current. Let us take a practical example of this. Suppose we have a valve or other suitable device having a resistance of 4 ohms. In series with this we place another 4 ohms resistance, and we connect the whole across a 4 volt battery. A current of $\frac{1}{2}$ an ampere would flow in this circuit.

Ballasting Resistors for Filament Control—(Continued)

A Practical Example

If, however, the resistance in series with the valve were made of very fine wire, this current of $\frac{1}{2}$ an ampere flowing through the wire would cause it to heat up, and it might conceivably cause the resistance to rise as much as 8 ohms. If this were the case, however, the current would only be one-third of an ampere instead of one-half. The resistance when the wire was carrying one-third of an ampere would not be as much as 8 ohms, so that the arrangement would finally settle down to a state of equilibrium at a value of current between $\frac{1}{3}$ and $\frac{1}{2}$ ampere.

Heat Radiation

There is another effect which has to be considered in determining the final conditions, and that is the fact that heat is being lost thewholetime by radiation and convection. A wire carrying a given current will rise to a definite temperature depending upon the value of the current and the condition of the air around. If the air is very still, and hot, then the loss of heat from the wire will be less than it would be if the air were cool, and were in a state of motion. Consequently the actual temperature to which the wire attains is dependent upon the local conditions, and this must also be taken into consideration.

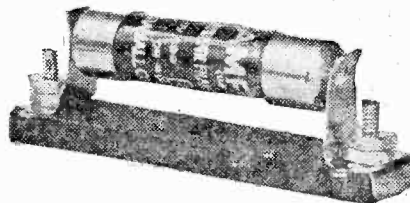

A commercial barretter—the "Amperite."

A State of Equilibrium

Let us return to the case we have just been considering. We reached the state of equilibrium where the current had so adjusted itself that the resistance of the hot wire satisfied the ordinary laws connecting the voltage, current and resistance in any given circuit. Suppose for instance that the voltage on the whole arrangement were increased slightly. The current through the whole circuit would momentarily increase, and this would cause an increase in the temperature of the hot wire. This in turn will produce an increase of resistance in the wire which will tend to reduce the current to its original value.

Automatic Compensation

If this state of affairs were actually achieved we should obtain the balancing action which we require. Obviously, however, the actual current produced will depend upon the material of the wire, its initial temperature, and the nature of the cooling arrangement around it.

The Problem

Stated in these simple terms, the problem would

appear to be comparatively easy. As a matter of fact, it is extremely difficult. Neither the temperature co-efficient of the metal (i.e., the rate at which the resistance of the wire increases as the temperature rises) nor the radiation of heat from the wire is a constant factor. In such circumstances it is obviously a matter of chance whether or not a true balancing action can be obtained so that the increase of resistance caused by an increase of the current is such as to bring the current back to its original value.

Special Conditions

The matter has been investigated theoretically and experimentally, and it has been shown that there are certain conditions to be fulfilled before the balancing action or "ballasting" can be obtained. What these conditions are need not be entered into now, since they do not affect the operation of the arrangement. It will suffice to say that satisfactory ballasting can be obtained in an iron wire in an atmosphere of hydrogen.

Hydrogen Atmosphere

It is found that the ordinary atmosphere does not produce the right degree of cooling. Moreover, it would obviously be impracticable to leave the ballast resistance exposed to air, since any sudden draught would cause a marked change in the cooling of the wire. It is found, however, that if the iron wire is enclosed in a glass vessel filled with hydrogen at a certain pressure, then, over certain ranges of temperature, the correct balancing action is obtained.

Definite Limits

This therefore reduces the problem to rather simpler grounds. If we can find definitely what

are the temperature limits between which ballasting can occur, then all that is necessary is to design the resistance so that when it is carrying its normal current the temperature of the wire lies within these limits.

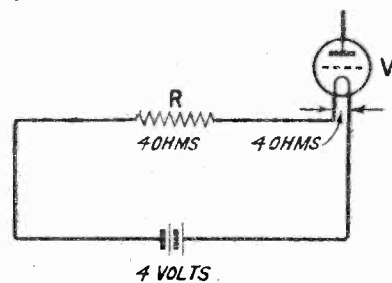

Fig.1.—These are the conditions required to run a 2-volt valve with a 4-ohm filament from a 4-volt accumulator.

The Valve Itself

The problem is now well on the way to solution, but there is still a further aspect of the question to be considered. In the example which we just considered we assume that the resistance of the valve remains constant throughout the experiment. This of course is not the case, and actually the

Ballasting Resistors for Filament Control—(Concluded)

resistance of an ordinary valve varies in a very marked manner with the current flowing through it. The filament characteristics of an ordinary tungsten filament valve indicate that a considerable change in the resistance occurs as the current through the valve varies.

Obviously, therefore, the barretter must be designed to work with a particular type of valve. It must be so arranged that, even allowing for any variation in the resistance of the valve itself due to changes of current, the current still remains appreciably constant.

experienced in actual practice. Over a comparatively short range of 3 or 4 volts only the current was maintained appreciably constant.

Considerable Utility

Such a device is of course of considerable advantage if the voltage applied is likely to vary appreciably. With a fixed resistance in series, of course, the current would rise with the voltage. A particular example of this is the use of a 60 milliamperes of .1 ampere valves with dry cells. The voltage of a dry cell itself varies from about 1.4 down to .9 or .8 at the end of its life. With such a wide variation (which moreover is almost continuous throughout the life of the cell) a fixed resistance is not a practical proposition. A barretter, however, can be designed for such valves, and will keep the current approximately at the correct value throughout the whole life of the dry cell.

Manufacturing Difficulties

As was stated earlier in this article, there are considerable manufacturing difficulties in these items. Although isolated barretters can be made which have very good properties indeed, to turn out such a delicately balanced instrument at a reasonable price of a few shillings only is a problem requiring considerable thought and care in the production. There is a very good range of these barretters made in America and now imported into this country, and very likely before long similar devices will be manufactured in this country for the amateur. Barretters have been made up by

several of the valve manufacturers in this country for various Government Departments, so that the manufacture is a practical and feasible proposition, and it may not be very long before we have English barretters available for amateur use.

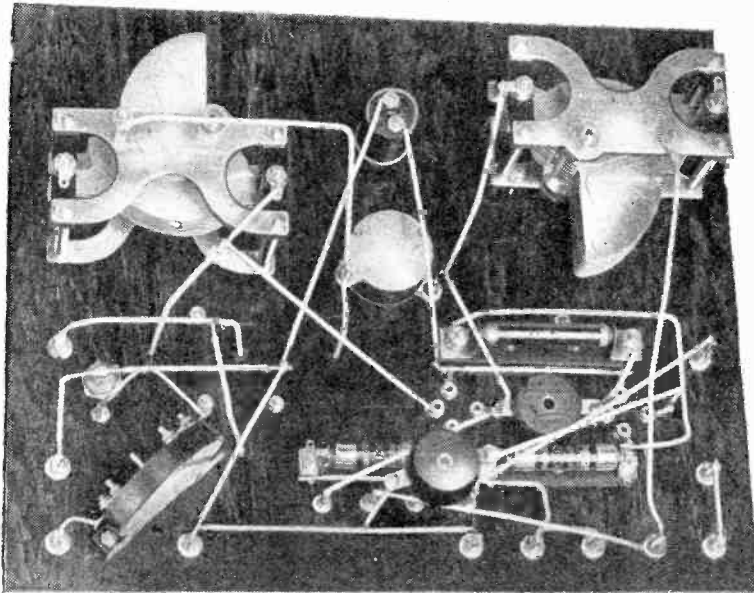

Ordinary interchangeable fixed resistances are now often used for filament control.

An Actual Test

It might be thought that this last point is not very important, but in practice it is found to be so. A commercial sample of a barretter was tested at Elstree a short time ago, and when connected in series with a fixed resistance (which did not change appreciably with the current flowing through it) the balancing action was found to be almost negligible. As the voltage on the whole combination increased, the current through the circuit also increased more or less in the same proportion.

A Distinct Difference

The device was then tried in series with a valve, and it was found that a very marked ballasting action occurred. At 5 volts the current was just under .25 of an ampere. When the voltage was increased to 15, the current only rose to .35. In this case, therefore, the ballasting action was not quite perfect, but the voltage range of 5 to 15 volts is very much outside what would normally be

The "DAVLOW THREE."

A single switch gives Daventry or the Low-Wave Stations.

Described by W. KAY in

The Wireless Constructor

AUGUST ISSUE.

Now on Sale. Price 6d.

FURTHER DEVELOPMENTS AT ELSTREE

COMBINING SELECTIVITY WITH SIMPLICITY

A LEAD TO AMERICA

Two Remarkable New Receivers

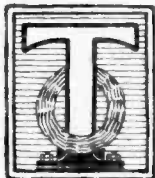

THE "Elstree Six," which has achieved such phenomenal success, was the result of consistent research which had been carried on for a period extending over some months. During that period much information came to light on the whole question of radio-frequency amplification, and various new and improved lines of research suggested themselves. These ramifications have been followed carefully to their conclusion with some very gratifying results.

Essential Features

There are one or two fundamental features which must be complied with in any high quality receiver. The first of these is selectivity. The present state of chaos in the ether necessitates razor sharp selectivity in order to obtain satisfactory distant reception which shall be free from interference. Another aspect, however, which is becoming of increasing importance is that of simplicity and ease of operation, and it is on these two aspects of the question which the efforts of our research have been directed.

Screened Coils

One of the outstanding successes of recent times has been the development of screened coils. This problem was first tackled by Mr. J. H. Reyner, who realised that, at the rate at which the science was progressing, the interaction between the various circuits in a high-frequency amplifier would soon prove an unsurmountable difficulty. He, therefore, inaugurated a series of experiments, as a result of which we have the now familiar screened coil.

Ahead of America

In this component we have definitely placed ourselves ahead of America. The principal American commercial receivers of to day are

being made with complete magnetic shielding, but the actual manufacture of a screened coil suitable for use by the amateur is not undertaken to any extent.

This product, therefore, of our Elstree Laboratories is the first step dispelling the idea that American components are essentially better than British.

Two Special Sets

These screened coils will be utilised in two special sets which will be described in the next issue of MODERN WIRELESS. One of these receivers will employ a new and highly satisfactory form of reflexing in which it is possible for one valve definitely to do the work of two. This remarkable set incorporates two high-frequency stages and one low-frequency, and has a selectivity very near to that of the "Elstree Six." As it only utilises three tuned circuits instead of four, the same high order cannot be quite obtained, but due to the use of the screened coils, the selectivity is greater than that hitherto obtained with only three tuning controls.

Real Reflexing

The effect of reflexing in this receiver is remarkable. No effect whatever is noticed on the high-frequency tuning circuits, which remain as sharply tuned and selective as with a straight set. At the same time the low-frequency portion actually operates as efficiently as a separate valve. This, in itself, constitutes a distinct advance in the science of reflexing, which, coupled with the fact that the receiver is extremely compact, makes for a very handsome unit.

A Long Felt Want

The other receiver, a straight five-valve set, satisfies a long felt need. One of the principal disadvantages of the straight high-frequency type of receiver is the fact that several tuning controls have to be operated before any

given station can be tuned in. At the same time the selectivity and quality obtainable with such receivers is now so good as to rival comparison with the Super-heterodyne.

Single Control

Attention has been directed, therefore, to the possibility of tuning two or more circuits with the same dial. The difficulties in the way of this are considerable, because the receiver must be simple to handle and to adjust in the first place. Any complicated balancing is out of the question, and in this quest for single control a large number of difficulties were encountered.

A Special Coil

These, however, have been satisfactorily overcome, with the result that the receiver in question will give a choice of a large number of different programmes by the simple rotation of a single dial. The receiver is further made attractive by the use of a special coil which has been developed by The London Electric Wire Co., Ltd., in association with the Elstree Laboratories, and which has a high-frequency resistance, inside its screen, lower than the best coils hitherto employed.

A Striking Article

Full details of these great achievements will be in the next issue of MODERN WIRELESS, which will be a special Autumn Double Number. In addition to the sets themselves there are several special features. Mr. John Scott-Taggart, F.Inst.P., A.M.I.E.E., contributes a striking article entitled "Greater Range and Selectivity," in which some remarkable developments will be disclosed. Mr. Percy W. Harris in an article entitled "The Trend of American Design" will tell the latest news of what home constructors and manufacturers in the United States are doing.

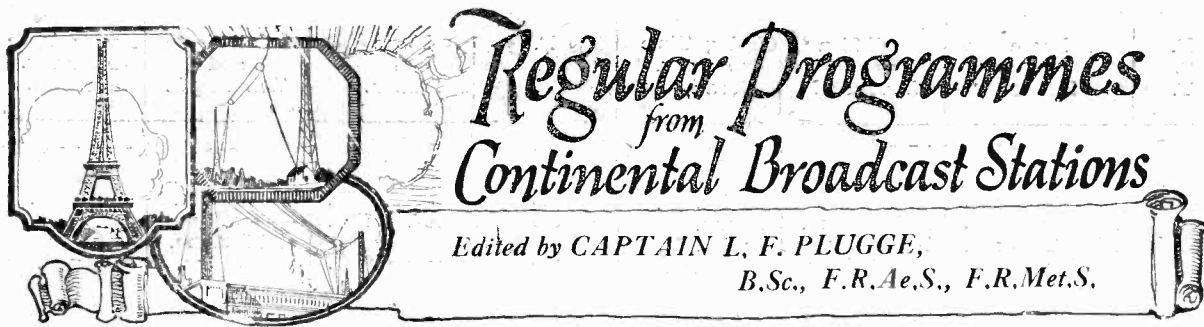

Edited by CAPTAIN L. F. PLUGGE,
B.Sc., F.R.Ae.S., F.R.Met.S.

Times reduced to British Summer Time.

Corrected up to July 23rd, 1926.

B. S. T.	Name of Station.	Call Sign and Wavelength.	Closing Time or Approx. Duration.	B. S. T.	Name of Station.	Call Sign and Wavelength.	Closing Time or Approx. Duration.
WEEKDAYS.							
a.m.							
7.30	Eiffel Tower	FL 2650 m.	10 mins.	7.30	Stockholm	SASA 430 m.	11 to 12 p.m.
7.55	Amsterdam	— 1950 m.	10 mins.	7.45	Oslo	— 382 m.	10 or 12 p.m.
8.5	Eiffel Tower	FL 2650 m.	15 mins.	8.0	Königswusterhausen	AFT 1300 m.	Midnight.
8.56	Eiffel Tower	FL 2650 m.	5 mins. Sp.	8.0	Stuttgart	— 447 m.	11 p.m.
9.40	Eiffel Tower	FL 75 m.	10 mins.	8.0	Göteborg	SASB 287 m.	10.30 p.m.
10.25	De Bilt	KNMI 1100 m.	5 mins.	8.0	Malmö	SASC 270 m.	10.30 p.m.
10.25	Eiffel Tower	FL 2650 m.	5 mins. Sp.	8.0	Sundsvall	SASD 545 m.	10.30 p.m.
10.40	Radio-Paris	CFR 1750 m.	10 mins.	8.0	Boden	SASF 1200 m.	10.30 p.m.
11.30	Eiffel Tower	FL 2650 m.	20 mins.	8.0	Lausanne	FB2 850 m.	9.30 p.m.
11.40	Hilversum	NSF 1050 m.	10 mins.	8.0	Copenhagen	— 347.5 m.	10.30 or 12.
				8.0	Radio-Wien	— 531 m.	10.30 p.m.
						and 582.5 m.	
p.m.				8.0	Prague	— 372 m.	10.30 p.m.
12.30	Eiffel Tower	FL 2650 m.	10 mins.	8.0	Radio-Paris	CFR 1750 m.	10 or 11 p.m.
12.30	Radio-Paris	CFR 1750 m.	2 p.m.	8.0	Eiffel Tower	FL 2650 m.	15 mins.
12.35	De Bilt	KNMI 1100 m.	5 mins.	8.0	Radio-Bruxelles	SBR 487 m.	10.10 p.m.
12.57	Nauen	POZ 3100 m.	8 mins. Sp.	8.0	Bratislava	— 300 m.	10 p.m.
2.45	Eiffel Tower	FL 2650 m.	10 mins.	8.0	Bilbao	EAJ9 415 m.	9.30 p.m.
3.0	Königswusterhausen	AFT 1300 m.	5 p.m.	8.0	Ecole Sup. des Postes	FPTT 458 m.	11 p.m.
3.50	Eiffel Tower	FL 2650 m.	10 mins.	8.0	Munster	ms 410 m.	10.45 p.m.
4.0	Zurich	— 515 m.	6 p.m.	8.0	Radio-Cartagena	EAJ16 335 m.	10 p.m.
4.0	(Union-Radio or Radio-Iberica)	EAJ7 373 m.)	6 p.m.	8.10	Königsberg	— 462 m.	11 p.m.
4.0	Radio-Castilla	EAJ4 340 m.	6 p.m.	8.15	De Bilt	KNMI 1100 m.	5 mins.
4.0	Voxhaus	b 504 m. and 571 m.	6.30 p.m.	8.15	Berne	— 435 m.	10.30 p.m.
4.10	Amsterdam	— 1950 m.	10 mins.	8.15	Zurich	— 515 m.	10 p.m.
4.30	Milan	IMI 320 m.	6 p.m.	8.15	Leipzig	— 452 m.	2 to 3 hrs.
4.30	Radio-Paris	CFR 1750 m.	5.40 p.m.	8.15	Frankfurt	— 470 m.	11 or 12 p.m.
4.40	Hilversum	NSF 1050 m.	5.40 p.m.	8.15	Geneva	— 760 m.	10 p.m.
5.0	Kiev	— 780 m.	7 p.m.	8.30	Mont de Marsan	— 390 m.	10 p.m.
5.0	Salamanca	EAJ22 405 m.	9 p.m.	8.30	Radio-Toulouse	— 430 m.	11 p.m.
5.0	San Sebastian	EAJ8 343 m.	7 p.m.	8.30	Budapest	— 560 m.	11 p.m.
5.15	Eiffel Tower	FL 2650 m.	10 mins.	8.30	Rome	IRO 425 m.	11 p.m.
6.0	Leningrad	— 940 m.	9 p.m.	8.30	Marseilles	PTT 351 m.	9.30 p.m.
6.0	Breslau	— 417 m.	7.30 p.m.	8.30	Breslau	— 417 m.	10 p.m.
6.0	Hamburg	ha 392.5 m.	7.30 p.m.	8.30	Hamburg	ha 392.5 m.	11 p.m.
6.0	Union-Radio	EAJ7 373 m.	8 p.m.	8.55	Eiffel Tower	FL 2650 m.	5 mins. Sp.
6.0	Munster	ms 410 m.	7.30 p.m.	9.0	Soro	— 2400 m.	9.30 p.m.
6.0	Radio-Barcelona	EAJ1 324 m.	7 p.m.	9.0	Milan	IMI 320 m.	11 p.m.
6.15	Stuttgart	— 447 m.	7.30 p.m.	9.0	Radio-Béziers	— 95 m.	1 hour.
6.15	Frankfurt	— 470 m.	8 p.m.	9.0	Radio-Viscaya	EAJ11 418 m.	11.30 p.m.
6.30	Eiffel Tower	FL 2650 m.	7.55 p.m.	9.0	Radio-Barcelona	EAJ1 324 m.	2 to 3 hrs.
6.30	Moscow	— 451 m.	8 p.m.	9.0	San-Sebastian	EAJ8 343 m.	11 p.m.
6.30	Leipzig	— 452 m.	8 p.m.	9.0	Radio-Catalana	EAJ13 460 m.	Midnight.
6.30	Königsberg	— 462 m.	7 p.m.	9.0	Salamanca	EAJ22 405 m.	11 p.m.
6.40	Hilversum	NSF 1050 m.	10 p.m.	9.10	Eiffel Tower	FL 2650 m.	11 p.m.
7.0	Brunn	— 521 m.	9 p.m.		(Radio-Iberica)	EAJ6 392 m.)	
7.0	Radio-Cadiz	EAJ3 357 m.	9 p.m.	10.0	(or Union-Radio)	EAJ7 373 m.	1 a.m.
7.0	Voxhaus	b 504 m. and 571 m.	Midnight.	11.20	Eiffel Tower	FL 2650 m.	5 mins.
7.0	Munich	— 488 m.	11 p.m.	11.44 a.m.	Eiffel Tower	FL 2650 m.	3 mins. Sp.
				12.57	Nauen	POZ 3100 m.	8 mins. Sp.

B. S. T.	Name of Station.	Call Sign and Wavelength.	Closing Time or Approx. Duration.	B. S. T.	Name of Station.	Call Sign and Wavelength.	Closing Time or Approx. Duration.
SUNDAYS.							
a.m.				8.0	Oslo	— 382 m.	Midnight.
8.56	Eiffel Tower ..	FL 2650 m.	5 mins. Sp.	8.0	Berne	— 435 m.	11 p.m.
9.0	Hilversum ..	NSF 1050 m.	10 a.m.	8.0	Prague	— 372 m.	10.30 p.m.
10.25	Eiffel Tower ..	FL 2650 m.	5 mins. Sp.	8.0	Radio-Wien ..	— 531 m.	10.30 p.m.
11.30	Königswusterhausen	AFT 1300 m.	12.30 p.m.	8.0	Lausanne ..	HB2 850 m.	9.30 p.m.
p.m.				8.0	Radio-Cartagena	EAJ16 335 m.	10 p.m.
12.14	Eiffel Tower ..	FL 2650 m.	10 mins.	8.0	Hamburg ..	ha 392.5 m.	11 p.m.
12.45	Radio-Paris ..	CFR 1750 m.	1.45 p.m.	8.0	Stuttgart ..	— 447 m.	11 p.m.
12.57	Nauen ..	POZ 3100 m.	8 mins. Sp.	8.0	Budapest ..	— 560 m.	Midnight.
2.40	Hilversum ..	NSF 1050 m.	4.40 p.m.	8.0	Radio-Agen ..	— 318 m.	15 mins.
4.0	{ Radio-Iberica ..	EAJ6 392 m.	6 p.m.	8.0	Radio-Paris ..	CFR 1750 m.	10.45 p.m.
4.0	{ Union-Radio ..	EAJ7 373 m.		8.0	Eiffel Tower ..	FL 2650 m.	10 p.m.
4.30	Zurich ..	— 515 m.	5 p.m.	8.0	Königswusterhausen	AFT 1300 m.	Midnight.
4.40	Milan ..	IMI 320 m.	6 p.m.	8.10	Königsberg ..	— 462 m.	10 p.m.
5.0	Bloemendaal ..	— 315 m.	2 hrs.	8.15	Copenhagen ..	— 347.5 m.	11 p.m.
5.0	Munster ..	ms 410 m.	7.30 p.m.	8.15	Zurich ..	— 515 m.	10 p.m.
5.0	Rome ..	IRO 425 m.	6.30 p.m.	8.15	Geneva ..	— 760 m.	1 hour.
6.0	Leningrad ..	— 940 m.	9 p.m.	8.15	Leipzig ..	— 452 m.	10 p.m.
6.0	Radio-Castilla ..	EAJ4 340 m.	8 p.m.	8.15	Radio-Bruxelles	SBR 487 m.	10.10 p.m.
6.0	Radio-Barcelona	EAJ1324 m.	8 p.m.	8.25	Breslau ..	— 417 m.	Midnight.
6.30	Bilbao ..	EAJ9 415 m.	8.30 p.m.	8.30	Marseilles ..	PTT 351 m.	9.30 p.m.
6.30	Eiffel Tower ..	FL 2650 m.	7.55 p.m.	8.30	Rome ..	IRO 425 m.	11 p.m.
6.30	Munich ..	— 488 m.	10.30 p.m.	8.30	Ecole Superieure	FPTT 458 m.	11 p.m.
7.0	Brunn ..	— 521 m.	11 p.m.	8.30	Radio-Toulouse	— 430 m.	11 p.m.
7.0	Hamburg ..	ha 392.5 m.	8 p.m.	8.30	Frankfurt ..	— 470 m.	Midnight.
7.0	Breslau ..	— 417 m.	8 p.m.	9.0	Milan ..	IMI 320 m.	11 p.m.
7.0	Helsingfors ..	— 318 m.	9.30 p.m.	9.0	Soro ..	— 2400 m.	9.30 p.m.
7.0	Warsaw ..	— 480 m.	10 p.m.	9.0	Radio-Viscaya ..	EAJ11 418 m.	11.30 p.m.
7.0	Radio-Cadiz ..	EAJ3 357 m.	9 p.m.	9.0	San-Sebastian ..	EAJ8 343 m.	11 p.m.
7.15	Goteborg ..	SASB 287 m.	10.30 p.m.	9.10	Eiffel Tower ..	FL 2650 m.	11 p.m.
7.15	Stockholm ..	SASA 430 m.	10.30 p.m.	9.15	Petit Parisien ..	— 333 m.	10.30 p.m.
7.15	Sundsvall ..	SASD 545 m.	10.30 p.m.	9.30	Radio-Catalana	EAJ13 462 m.	Midnight.
7.15	Boden ..	SASE 1200 m.	10.30 p.m.	10.0	{ Radio-Iberica ..	EAJ6 392 m.	1 a.m.
7.15	Malmo ..	SASC 270 m.	10.30 p.m.		{ or		
7.30	Leipzig ..	— 452 m.	Midnight.		{ Union-Radio ..	EAJ7 373 m.	
7.30	Voxhaus ..	b 504 m. and 571 m.	Midnight.	11.44 a.m.	Eiffel Tower ..	FL 2650 m.	3 mins. Sp.
7.30	Bratislava ..	— 300 m.	9.30 p.m.	12.57	Nauen ..	POZ 3100 m.	8 mins. Sp.
7.50	Hilversum ..	NSF 1050 m.	10.30 p.m.				

B. S. T.	Name of Station.	Call Sign and Wavelength.	Situation.	Nature of Transmission.	Closing Time or Approx. Duration.
----------	------------------	---------------------------	------------	-------------------------	-----------------------------------

SPECIAL DAYS.

p.m.					
5.0	Radio-Bruxelles ..	SBR 487 m.	Brussels ..	Tues., Thurs., and Sat., Concert, followed by News	6 p.m.
7.0	Nijni Novgorod ..	— 860 m.	Russia ..	Tues. and Thurs., Concert and Opera	11 p.m.
7.0	Sokolniki ..	— 690 m.	Russia ..	Mons., Wed., and Fri., experimental Transmissions	8.30 p.m.
8.30	Ryvang ..	— 1160 m.	Denmark ..	Tues., Wed., and Sat., Concert	10.30 p.m.
8.30	Le Matin ..	— 1750 m.	Paris ..	Saturday, Special Gala Concert	11 p.m.
9.15	Petit-Parisien ..	— 333 m.	Paris ..	Tues., Thurs., and Sat., Concert (Items announced in English as well as French)	11 p.m.
10.0	Lucien Lévy ..	LL 350 m.	Paris ..	Mon., Wed., and Fri., Concert	11 p.m.
10.30	Copenhagen ..	— 347.5 m.	Denmark ..	Thurs. and Sat., Dance Music from Restaurant Nimb	12.30 a.m.
11.0	Oslo ..	— 382 m.	Norway ..	Wed. and Sat., Dance Music from Hotel Bristol	Midnight.

READ "WIRELESS" INCORPORATING "WIRELESS WEEKLY" EVERY TUESDAY PRICE 2d.

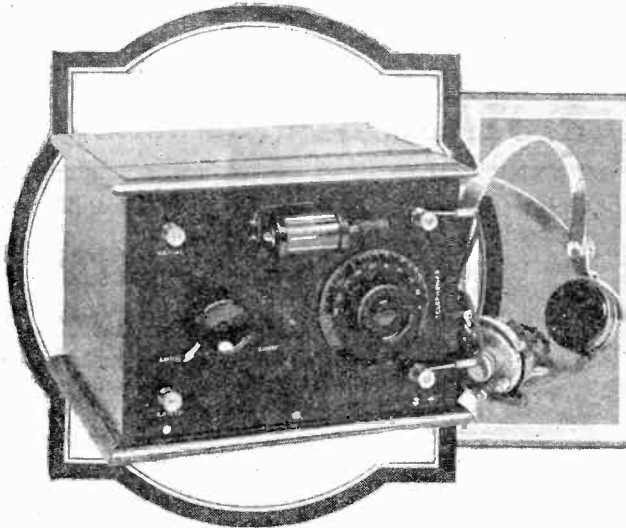

A NOVEL CHANGE-OVER CRYSTAL SET

By
D.J.S. Hartt, B.Sc.

An attractive little set employing a novel device with the aid of which it is possible to receive either the local station or 5XX without changing the coils.

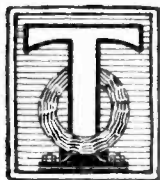

HERE are a number of points about a crystal receiver which should receive due attention if it is to fulfil the demand for a satisfactory "family" receiver which anyone can operate. First and foremost, it should have a detector of such a type that the adjustment remains permanent, or one that is capable of easy adjustment, so that a delicate setting

variable condenser. Finally, there should be some simple arrangement whereby it is possible to change over rapidly from the local station to Daventry.

The receiver to be described fulfils these requirements, and embodies a rather novel idea in the tuning arrangements.

which the two coils are connected in parallel and the condenser in series, and the other with the two coils in series and the condenser in parallel.

Now you should know that if two coils are placed in series, we obtain an inductance approximately equal to the sum of their individual inductances, and that if two identical coils are connected in parallel, the resultant effective inductance is about half that of either of them.

The Circuit

A glance at the circuit diagram will show that a three pole change-

Fig. 1.—The theoretical circuit, showing the switch connections.

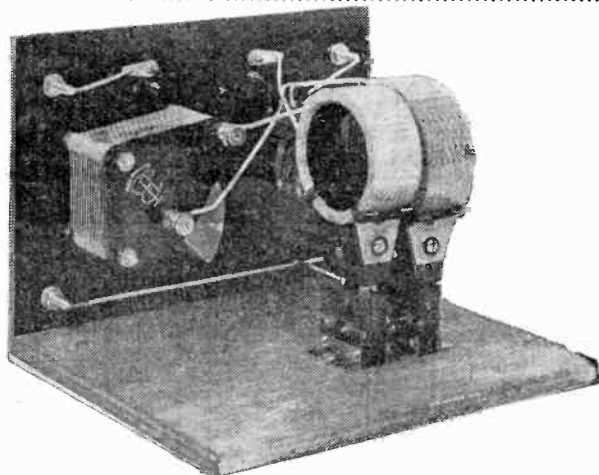
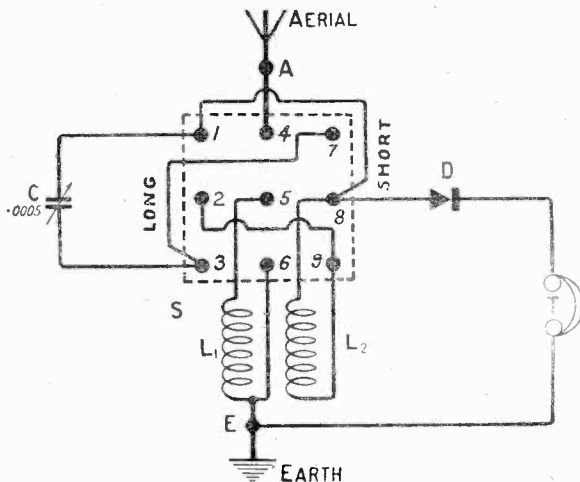

A simple movement of the switch places the two coils in series or parallel for the reception of 5XX or the local station.

which will remain constant over a long period is possible.

Other Desirable Features

Secondly, the tuning arrangements should be simple, preferably employing fixed coils and only one

over switch is used, that is a switch with six contacts. Two coils are also employed, which are fixed and in a definite position relative to each other. Also there is one variable condenser.

By means of the switch we are able to obtain two circuits, one in

This, then, gives us a very effective means of varying the inductance in circuit, and yet at the same time of keeping the coils fixed.

Series and Parallel

Moreover, it is possible to choose two coils so that, with the parallel

A NOVEL CHANGE - OVER CRYSTAL SET—(Continued)

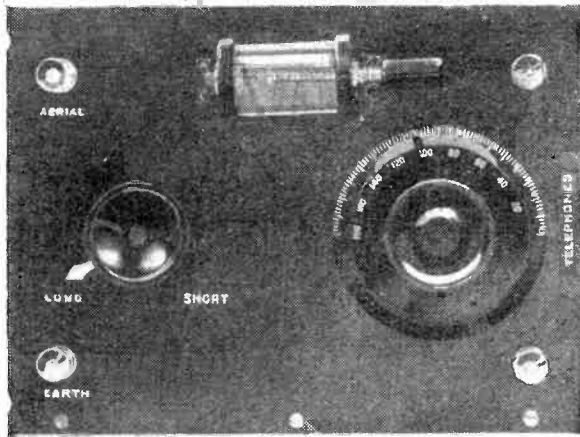

The change-over switch enables the local station or 5XX to be received without alteration in coil sizes.

connections and a .0005 variable condenser in series, the set will tune to a local station in the broadcast range, yet 5XX can be tuned in with the other combination, that is, with the coils in series and the condenser in parallel across them. The two circuits are shown in

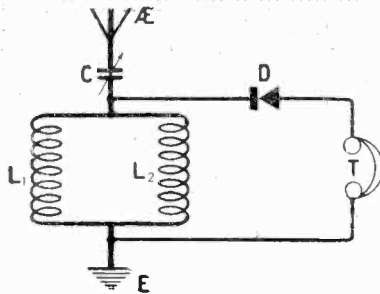

Fig. 2a.—Showing the arrangement of the coils for the ordinary broadcast band.

Fig. 2, (a) being the connections used on the broadcast band and (b) the circuit for 5XX.

Constructional Details

Reference to the photographs will show that the constructional work involved is simple, yet the finished receiver presents a neat and businesslike appearance.

The crystal detector, which is of the micrometer adjustment type, is mounted in an accessible position on the front of the panel at the top. The aerial and earth terminals are on the left, and those for telephone connections are on the right hand side.

The knob controlling the change-over switch is seen on the left and to the right of this is the dial of the variable condenser. The two coils are mounted on the baseboard inside the cabinet.

given subsequently for the guidance of constructors. If you happen to have by you any other suitable components of good make, there is no reason why you should not incorporate these, otherwise you might as well adhere to the specification.

One polished Radion panel, black, 6 inches by 8 inches. (American Hard Rubber Co.)

One suitable cabinet (Carrington Manufacturing Co.), complete with baseboard, 8 inches by 7 inches.

One crystal detector panel mounting type. (Burndept Wireless, Ltd.)

One .0005 variable condenser (that used is one of the older pattern ebonite end plate models by Jackson Bros.)

One three pole, two-way switch, "Utility," knob type. (Wilkins & Wright.)

Four terminals.

Components Required

The components required are few and not very expensive. A list of those actually used, together with the names of the manufacturers or their trade marks, is

Two single coil mounts. (Burne-Jones & Co., Ltd.)

Glazite wire, wood screws, and Radio Press panel transfers.

Making the Set

The first operation in making the set is to mark out the panel on the reverse side according to the drilling

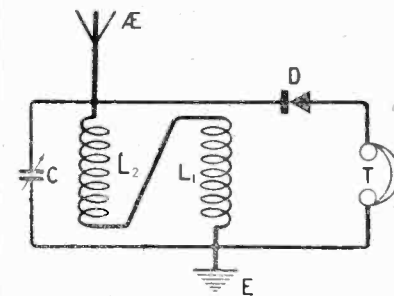

Fig. 2b.—How the coils are joined for receiving 5XX.

diagram. Normally, the positions for the drilling centres are marked out on the back of the panel in the reverse sense, but since in this particular case the lay-out is symmetrical, you cannot make an error.

The positions for the drilling centres of the holes for the fixing screws of the crystal detector are carefully marked out with the aid

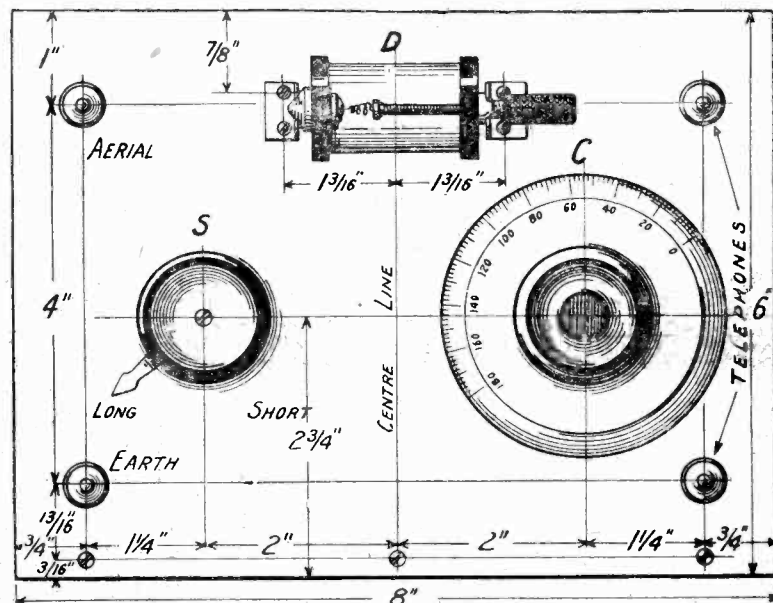

Fig. 3.—This simple drilling diagram can be obtained full size. Blue Print No. 171a, free.

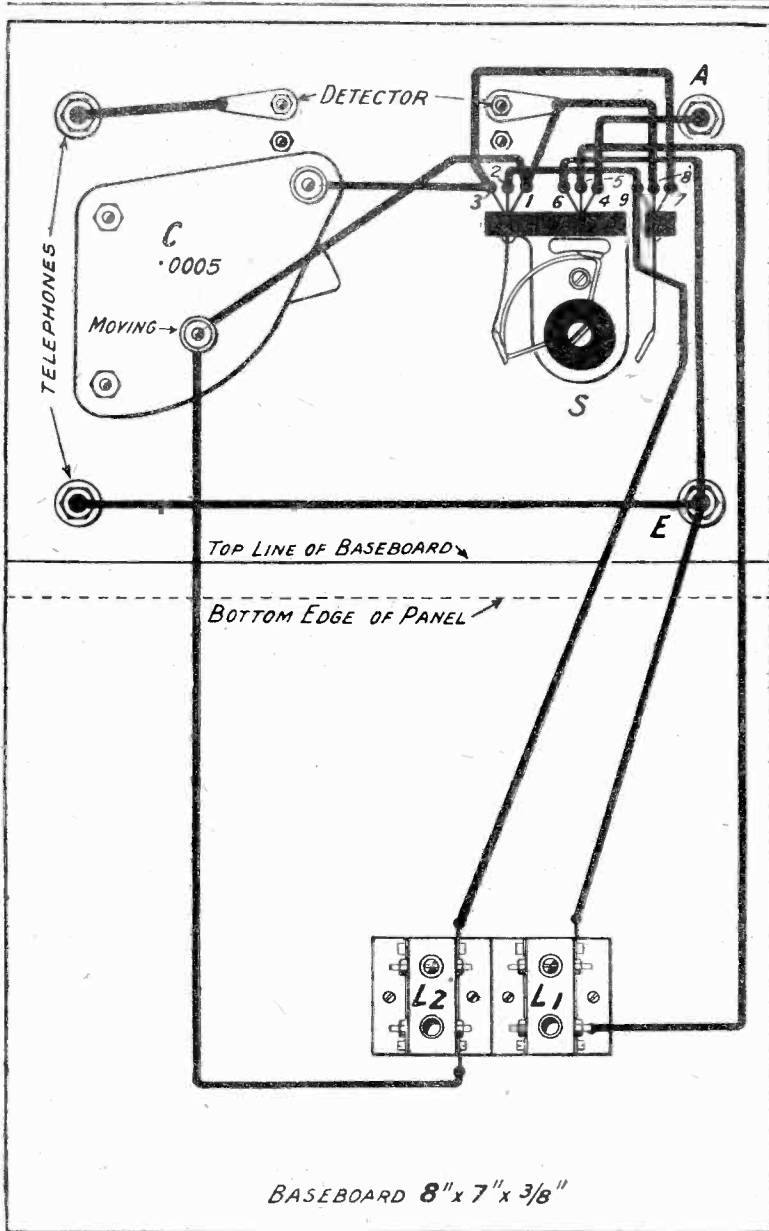

Fig. 4.—In wiring up the switch full use should be made of the Figs. 1 and 5 diagrams. Blue Print No. 171b, free.

of the drilling template supplied with this component.

In addition to the drilling centres marked out on the front of panel drawing, mark out the positions for three holes to take wood screws to secure the panel to the baseboard. This method of fixing is adequate, and no angle brackets are required.

Proceed then to drill the necessary holes, and when this operation is finished clean up the panel and all the components with a duster.

A Warning

The components should then be mounted, with the exception of the

A NOVEL CHANGE-OVER CRYSTAL SET — (Continued)

crystal detector, which first requires some further attention. Do not fail to comply with the instructions given in the warning issued with this component, to the effect that the insulating black lacquer should be removed from the threads, and under the heads of the fixing screws, and also from the supporting brackets, where they come into contact with the screw heads. This can quite easily be done with the aid of a penknife and a small piece of emery cloth.

Solder the Connections

All that remains to be done is to solder the connections. Glazite wire is quite simple to use, and makes a neat wiring job. To remove the covering an incision is made into it round the wire, with the aid of a sharp knife, and the covering is then stripped off. If it is desired to make a join to the middle of a piece of Glazite, two cuts are made and the covering between them is removed. Take

(Concluded on page 283.)

Wiring up will be simplified if this photograph is used in conjunction with Fig. 4.

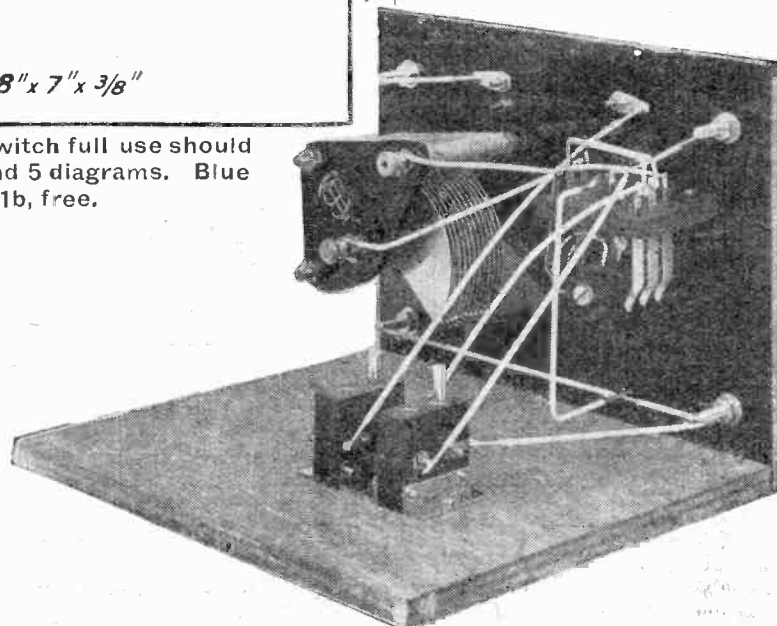

JUDGING FOR THEMSELVES

Some of our Readers who have Heard the
 "Elstree Six" Demonstrated.

ASHFORD.

L. Lewis.
 E. J. Terry.
 W. Westlake.
 A. L. Westlake.

BEXLEY.

E. Whomes.
 H. Marsh.

BYFLEET.

H. S. Cawsey.

BATLEY.

E. Smith.

BECKENHAM.

E. C. Robinson.

BUSHEY HEATH.

G. W. Asbery.
 I. E. Tomlinson.

BRISTOL.

R. Hooper,
 Colham, Bristol.

BELMONT.

M. A. Mason.

BRIGHTON.

H. E. Pittman.
 T. Attwater.
 T. Vingo.
 J. A. Marrez, Hove.

BEAULIEU.

C. Hodgkinson.

BIRMINGHAM.

H. Riley.

CHINGFORD.

W. L. Lee.

CLACTON-ON-SEA.

T. W. Wimsley.

COLCHESTER.

E. Clift.

CHORLEY WOOD.

S. Hall.

CAMBRIDGE.

Dudley G. Euston.

CHEAM.

J. T. Quick.

DUNDEE.

A. Pride.

ESHER.

A. L. Pugh.

ELSTREE.

L. T. Croft.

GUILDFORD.

H. L. Welks
 A. D. G. Shelley.

GREENHITHE.

A. H. Grimsey.

HODDESDON.

J. C. Haward.

HESSLE.

G. Hepton.

HEATON CHAPEL.

Albert Hall.

HIGH WYCOMBE.

W. C. Morrison.

KETTERING.

Paul Taylor.
 L. Barlow.

LIMPSFIELD.

J. F. Forwood.

LUTON.

W. Folds, Wandon End, nr.
 Luton.

A. A. Hudson.

MIDDLESBROUGH.

A. C. Bulmer.

MAIDENHEAD.

J. Green.

MAIDSTONE.

W. A. Stevens.

MILFORD.

W. Riches.

NEW MALDEN.

C. B. Teynson.

NORTHWOOD.

R. S. Cox.

NOTTINGHAM.

J. Hibbett.

OSWESTRY.

H. W. Thomas.

RAMSGATE.

H. L. Hurst, Pegwell,
 Ramsgate.

PORTSLADE.

C. S. Dyer.

READING.

H. W. Lee.

R. Messer.

J. Penny.

C. Smith.

F. A. Cox.

ST. ALBANS.

H. Gusson.

SALISBURY.

S. Collett.

SEVEN KINGS.

E. A. Ward.

STANMORE.

Capt. H. Kendervoir.

SOUTHAMPTON.

W. A. E. Evans, St. Denys,
 Southampton.

SOUTHEND-ON-SEA.

H. Revell.

SUTTON.

P. H. Sheath.

SURBITON.

C. A. Partner, Tolworth,
 Surbiton.

A. H. Partner, Tolworth,
 Surbiton.

A. Waters.

TUNBRIDGE WELLS.

T. H. Wade.

TJORPE.

C. Wilkinson.

WALTON.

G. Blandford.

WATFORD.

A. M. Allen.

C. Copping.

G. A. Crockett.

WATERFORD, IRELAND.

R. H. Carew.

WEST DRAYTON.

B. S. Tuke.

WINDLESHAM.

G. Hartwright.
 H. White.

LONDON.

F. Gidding, Hanwell.

H. D. Dean, N. 2.

S. Pinsensy, S.E. 13.

W. Gregory, W. 6.

M. Pickard, S.W. 5.

C. Spencer, S.W. 3.

H. Willis, Catford, S.E.

R. W. Emerson, N.W.

A. H. Brackensy, N. 3.

H. Hogg, S.E. 18.

J. Barrow, S.W. 11.

J. Lane, S.E.

W. B. Choke, W. 14.

H. Thompson, E.C.

J. Vines, N. 10.

A. Sabini, S.W.

C. C. Springer, Cricklewood.

R. Whittington, N. 19.

G. Crawford, S.W. 5.

J. H. Russell, N.W. 10.

E. Glasson, N.W. 2.

G. Percival, S.W.

G. Fry, Croydon.

H. Tollington, Croydon.

G. Tozen, Croydon.

S. C. Bellham, S.W. 1.

F. Lallemand, E.C. 1.

A. Jacquemin, N. 7.

Chas. Hill, S.E. 15.

A. E. J. Symonds, W. 11.

F. E. Wade, E.C. 2.

H. F. Newton, S.E. 20.

H. Hurst, Edgware.

H. E. Blaxill, Enfield.

H. A. Myles, Croydon.

F. S. Taylor, Croydon.

C. B. Beacon, S.E.

J. Parker, N.W. 2.

E. Gibbs, E. 17.

J. Collins, N.W.

A. Knight, S.W.

L. Greenwood, N.

D. S. Horder, E.C.

W. Penney, N. 21.

F. Edwards, W.

E. Cranfield, Ilford.

A. C. Bonvalot, N.W. 3.

H. Laver, c/o G.P.O. London.

G. Johnson, Ilford.

G. W. Havler, W. 2.

F. W. Webb, Crouch Hill.

S. Davies, S.E. 5.

C. Bevan, W. 9.

J. Pallister, W. 10.

W. H. Whybourne Reed, E. 10.

W. C. Tuke, Edgware.

A. H. Howard, S.W. 12.

C. Bird, W. 10.

W. Fox, E.C.

A. H. Binnie, S.W. 14.

James McCae, S.W. 14.

B. W. Godfrey, S.W. 15.

H. J. Wilson, N. 15.

A GREAT INVENTOR AND THE "ELSTREE SIX"

LONDON—continued.

A. A. Hall, W. 1.
 C. A. Reckrand, S.W.
 H. Noel, N.W.
 D. Neilson, N.W. 5.
 D. Edgand, S.W.
 A. Mitchell, Ilford.
 G. R. Judge, E. 12.
 W. Wassef, B.Sc., S.W.
 W. J. Atterton, W.
 A. G. Quinlivan, E. 11.
 R. Sullivan, S.W. 4.
 Miss M. Johnson, S.W. 4.
 A. Albone, Edgware.
 S. J. Aland, S.W. 6.
 A. H. Bird, S.E. 15.
 H. G. Tugwood, N. 3.
 S. Wyman, S.W. 18.
 A. G. Watson, N. 16.
 A. W. Christie, W. 1.
 H. Everett, S.E.

D. Henry, N. 17.
 F. Ellis, S.E. 23.
 A. Huelseke, N.W. 1.
 — Catlow, Willesden Green.
 D. Anderson, S.W. 11.
 Dr. Washington Isaacs, W.C. 2.
 W. J. Foster, S.W.
 F. R. Winton, W.C. 1.
 W. Mitchell, W. 9.
 G. E. Dickinson, N.
 R. G. Miles, S.W. 6.
 H. H. Hope, N.
 H. L. Jones, S.E. 23.
 A. Hanscomb Edge, S.W. 19.
 Wm. Stock, S.E. 17.
 C. Latham, N. 20.
 L. Harvey, N.W.
 H. Ede, N. 6.
 J. M. Welshman, S.W. 1.
 — Davidson, E.C.
 — Wright, E.C. 2.
 — Pahl, E.C. 2.

P. Patterson, E.C. 2.
 — Roberts, N. 19.
 H. M. Toulmin, S.W. 5.
 C. P. Yapp, S.W.
 — Fenny, W. 1.
 S. Andrews, W. 5.
 H. Smith, Muswell Hill.
 Chas. Keys, S.E. 19.
 G. Hayes, W. 8.
 K. Adair, W.
 G. Deadman, W. 8.
 J. D. Drake, Bow, E.
 C. H. Crombie, Chelsea.
 W. Pringle, N. 8.
 A. Atkin, N.W. 10.
 H. V. Major, S.E.
 A. A. Blake, N.W.
 Dr. Drinkwater, W. 1.

GERMANY.

S. K. Herbert, Ahrensburg,
 i/Holstein.

NOTE.—Many of the above have notified the Editor that they will be pleased to answer questions by local enquirers. For detailed addresses apply to the Editor.

"EQUAL TO THE BEST I HAVE HEARD IN AMERICA."

PROFESSOR HAZELTINE'S OPINION OF THE "ELSTREE SIX."

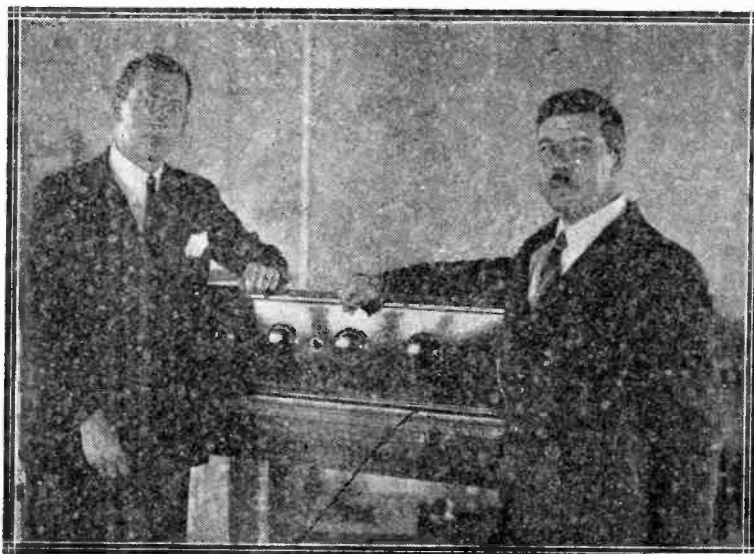

On Wednesday, 14th July, Professor Hazeltine, the day after his arrival in England, paid a visit to the Radio Press Laboratories at Elstree and himself tested the "Elstree Six." His opinion, expressed after tuning in a number of stations, was, "Equal to the best I have heard in America"—a striking tribute from so great an inventor. In the above photograph, taken during the visit, Mr. Scott-Taggart is seen on the left and his guest on the right.

"I feel that while we in America call the receiver the Hazeltine Neutrodyne, we should in England call it the Scott-Taggart Neutrodyne," said the Professor, referring to the receiver generally associated with his name.



ALTHOUGH there is not the slightest doubt that it is the general tendency to go downwards, not upwards, in the scale of wave-lengths to-day,

there is a surprising amount of interesting work going on round about 1,000 metres still. I have been spending quite a lot of time up there during the past month, and have been quite astonished at the experimental work still being carried out on this wavelength, and, indeed, all the way up the scale to 20,000 metres.

Most of it is done in Morse code, so that, unfortunately, it does not interest the average broadcast listener very much. Those who are not acquainted with the code, however, can best learn it by going up to 4,100 metres and taking down the Air Ministry weather bulletins (in bits at first, of course!), so that the longer waves are to be recommended for both classes of listener.

A Contrast

THE chief thing that struck me about the long-wave Morse stations was the strange effect of their code compared with that turned out by the amateur transmitters on the shorter waves. Don't think that I am belittling the amateur's capabilities—I don't mean that his Morse is bad, but those that have had much experience of fading and atmospherics on short waves get into a habit of length-

ening their dashes, and sometimes their dots as well, for the purpose of "cutting through" the interference better, and the clear-cut "mechanical"

Morse of the long-wave station operators sounds rather strange at first after one has been "down below" for a long time. I am guilty of the "faults," if such they be, myself, so I hope that no amateur transmitter will descend on me for these remarks!

Be Careful!

ROUND about 1,000 metres there are always innumerable Air Ministry stations to be heard, and generally you will find five or six of them all transmitting at once. As they all sound exactly alike, it often comes as a surprise after you have been receiving, say, Cranwell, GFC, to find that your hand slipped and you ran into Felixstowe, GFF, without knowing it. Things like this have happened to me more than once!

Any morning at 10 a.m., between 1,130 and 1,300 metres, you will hear the local synoptic weather reports transmitted by GFC, GFF, GFL, GFM, GFO, GER and GEY, in the order mentioned.

Time from FL

THE time signals also are yet a source of interest to many who still possess their 250 and 300-turn coils. The well-known spark note of FL does not really seem to have changed very much since I took up Radio (or,

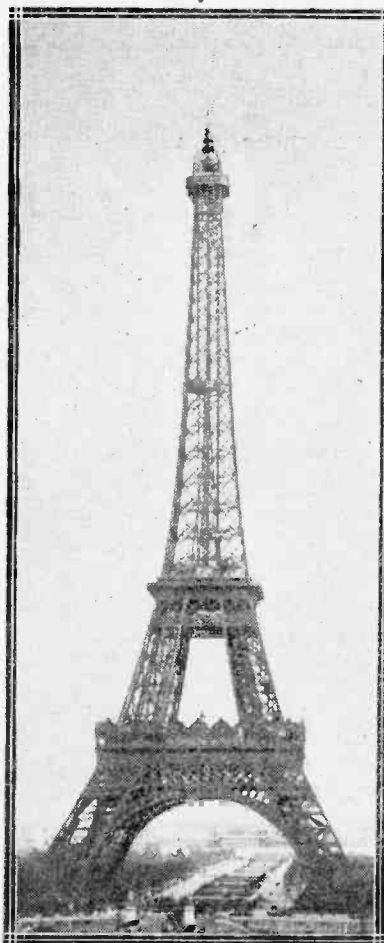

The Eiffel Tower's strong signals are largely due to the height of its aerial system.

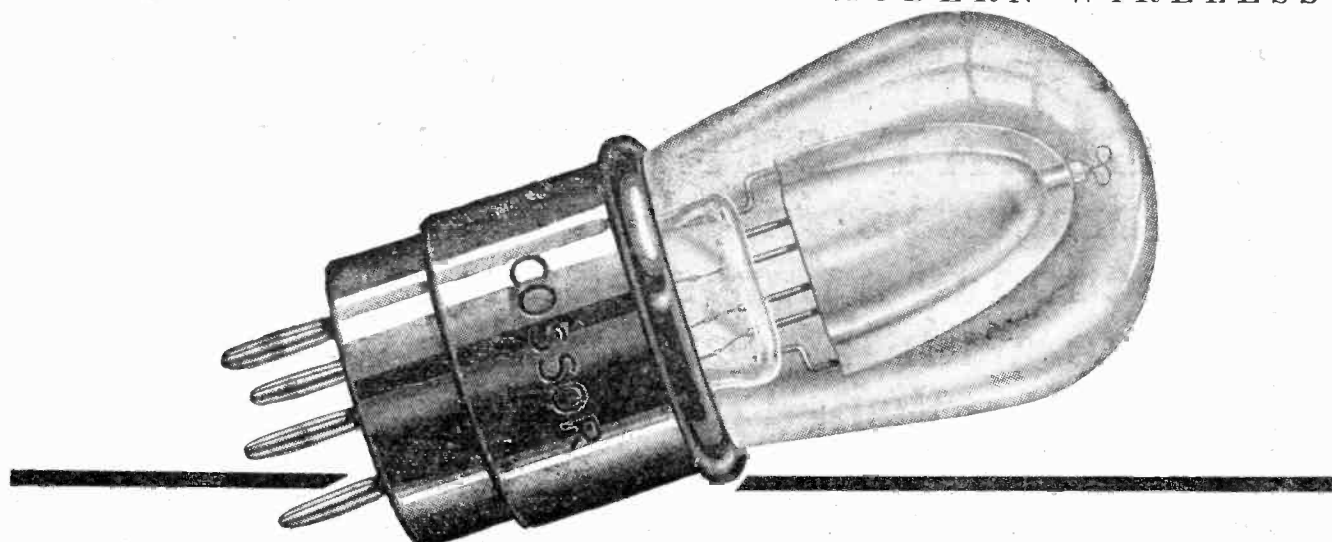

At last the shockproof Valve

THERE is little need to ask "Which is the most vulnerable part of any valve?" Even a man who had never owned a Wireless Set would be able to guess the answer! Ever since Edison ransacked the world for filament material for his first electric lamp, the glowing thread within its crystal globe has been an object of special regard.

The wireless valve is first cousin to the electric lamp—but year by year the relationship is getting more remote. Whereas in the latter, efficiency is measured by the amount of light it gives, the whole resources of Science have been enlisted to obtain in the valve the maximum of efficiency with the minimum of light.

And now that a new Cossor Valve has been evolved with a special filament which operates at a glow almost indiscernible we appear to be within a reasonable distance of a valve which will never wear out.

But filament glow has been only one of the problems which Cossor has faced—and conquered. Another—almost equally as important—has been the perfection of a system of filament suspension which would successfully withstand the thousand and one shocks which every valve must encounter in use.

The Cossor Point One, now being placed on the market, is the

first valve in which the new system of Co-axial Mounting has been utilised. For the first time there is available a method which enables the three elements—the Filament, the Grid and the Anode—to be securely united together at the top as well as at the bottom.

How this is effected can be readily understood from the illustration above. At the top of the Anode will be seen a seonite insulator which—projecting downward—is firmly secured to the top of the Grid. Through the centre of this seonite tube is threaded a fine wire which acts as the third support to the fila-

ment. Thus it has been found possible to evolve a system of construction which will resist without harm the hardest of shocks. Even if the elements in this Cossor Point One should be displaced through an accidental blow they must always be in the same relative positions.

Co-axial Mounting is destined to be one of the most important developments of the year. In this brief announcement it is obviously impossible to enlarge in detail upon its many advantages.

Try out this astonishing new Valve now. Remember its current consumption is barely one-tenth of an ampere. One super-heterodyne fitted with seven of them actually takes less current than a single-valve Set using one ordinary valve.

The new Cossor Point One

—the first Valve in which the filament, grid and anode are secured together at top and bottom in permanent alignment.

Red Top	Plain Top	Stentor 2,
For H.F. use	For Detector	Power Valve
18 volts	18 volts	18 volts
1 amp.	1 amp.	15 amp.
15/6	15/6	18/6

—fitted with the new '1 amp. filament

A GREAT STRIDE of progress is embodied in the perfection of a new all-British ebonite with a non-metallic leak-free polished surface by REDFERN'S, who have studied rubber manufacture for a quarter of a century.

In EBONART utility is allied to beauty. The brilliant polish of EBONART resists condensation of moisture: it is absolutely without metallic influence, and is therefore non-conducting and adds immensely to the appearance of a Radio set. EBONART is sold in black and in a lovely mahogany shade.

∞ [Made in panels from 6 in. x 6 in. to 24 in. x 12 in. in black polished surface and mahogany polished surface. Also in Black Egg-shell Matt, having great beauty of surface.] ∞

*Made in
England
by Redfern*

Ebonart
NON-METALLIC SURFACE

REDFERN'S RUBBER WORKS, LTD.
HYDE - - - - - Cheshire
LONDON - - - - - 75 Newman Street, W.1

See these panels on Stand 94 (Ground Floor) at the National Exhibition, Olympia, commencing Sept. 4th.

OFF THE BEATEN TRACK — (Concluded)

I suppose I should say, "wireless"!). At 10 a.m. G.M.T. the vernier time signals are transmitted as usual, and the older types of signals are sent out at 9.23 a.m. and 10.44 a.m., as well as at other times during the day.

A Step Lower

COMING down a little to the 900-metre region, beloved of amateur demonstrators in pre-broadcast days, I notice that Croydon's almost proverbial generator-hum is still the same as ever. Perhaps the operator knows what an "official" effect it gives them. Although one can tell that there are two operators on duty there by listening to their transmissions, they certainly sound rather similar "on the air," yet their

With the Amateurs

SPEAKING of SOS calls, the last one I heard was, strange as it may seem, from a Belgian amateur on a wave of 45 metres. It was at the time that the floods in Belgium were at their worst, and the owner of this station had all his gear in a "shack" in the garden. He had reported before that he had to put on a pair of golshes to get out to the shack, but the last that was heard of him was that he and his entire transmitter were floating slowly down the street! I did not hear what was happening to his aerial at the time. Presumably it was going with him!

The amateurs are just as busy as ever, and there is no doubt whatever that the 45-metre band is the centre of attraction for them nowadays. On

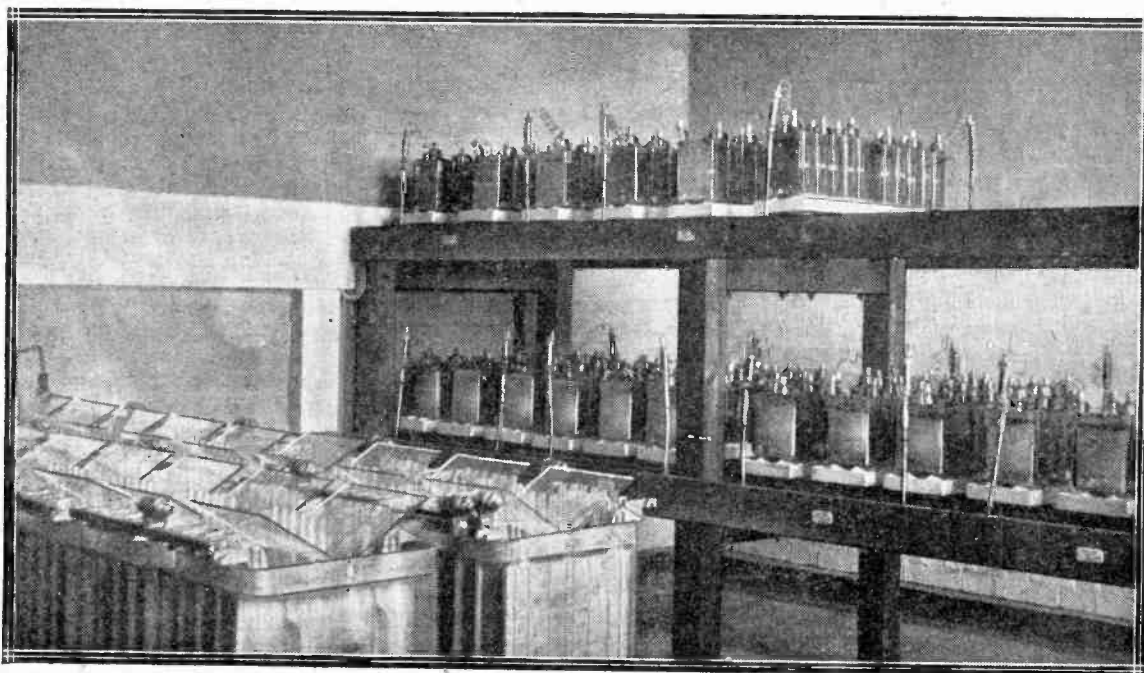

Large banks of accumulators are used for the lighting and the receivers at the Burnham station, the receiving station for the long-distance ship traffic.

voices are entirely different in actual life. There are several other cases like this that I know of, chiefly among the amateur transmitters that have two "ops."

The 600-metre band is, to my mind, the most conservative of wavelengths. It is just the same as ever, with the same old characteristic notes of GNF (North Foreland), FFB (Boulogne) GNI (Niton) and occasionally GNV (Newhaven), beloved of broadcast listeners in Brighton. I have not heard an "SOS" up there for some time now; but I well remember the "station-chasing" I used to do occasionally in the old days when there was an alarm. One used to be able to follow the distress call from the Lizard right round the coast by GNF and up to Cullercoats.

the lower wave-band (round about 23 metres) there is really very little to be heard except WLL, an American commercial station, and 2XS, one of the experimental stations of the G.E.C. at Schenectady, already famous as the home of WGY. On 28 metres and upwards, however, signs of activity are immediately apparent. NKF may be heard at all times of day and night on about 29 metres, his strength on this wave being greater than on any other that he has used. A little higher still, between 30 and 36 metres, several Brazilian stations are to be heard any night after about 10.30 p.m., a single valve being quite sufficient to give excellent signals in the telephones. Other stations heard on these wavelengths are the R's (Argentine), and CH's (Chile). W. I. S.

HOW TO USE THE SCREENED COIL

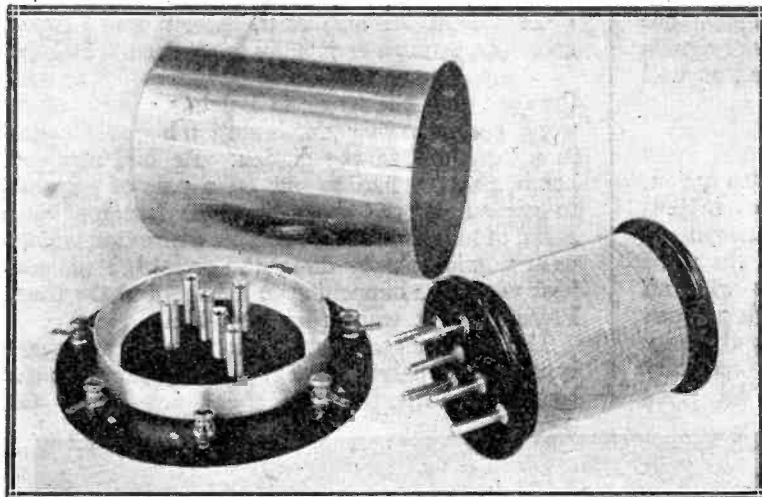

By
J. H. REYNER,
B.Sc., A.M.I.E.E.



Full details of the new non-interacting coils which have been developed at the Elstree Laboratories.

Interchangeability is one of the attractive features of screened coils.

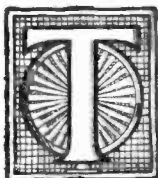

THIS winter is going to be a screened coil season. It has been recognised for some time that one of the principal

sources of trouble to be overcome, in designing really satisfactory long range receivers, was the actual magnetic interaction between the various circuits. In consequence I undertook some months ago a series of investigations as to the exact effects of screening, and to what extent a partial screening would prove satisfactory.

Complete Screening Essential

These investigations showed that for satisfactory results the screens had to be almost complete, that is to say that the coil had to be enclosed on all sides in a metal case. Reasonably good results could be obtained by using perforated sheet instead of solid metal, and this had the advantage that leads could actually be brought through the perforation of the screen.

Perforated sheet, however, is more expensive than solid sheet, and after some consideration it was decided to evolve a type of screened container which would be satisfactory for all the usual circuits and provided with some means of taking connections into the coils inside.

The Commercial Articles

The commercial form of this container is now fairly familiar to our readers. It consists of a metal base

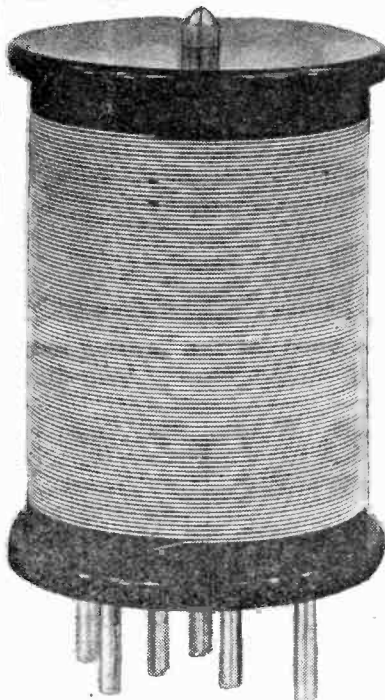

The windings consist of simple single-layer coils.

provided with a flange of some sort, over which a cover is fitted. The arrangement is somewhat like an

ordinary cocoa tin, the lid of which would form the base, while the tin itself comprises the screening cover which is fitted on afterwards. Through this base six sockets project, insulated, of course, from the metal base itself, and connections are taken from these sockets to a series of terminals placed on the outside of the base, so that connection can be made to the sockets when the cover is in position.

The Coils

The coils themselves are wound up on a former provided with six pins which fit into the sockets in the base, and by this arrangement either simple coils (either tapped or plain) or transformers can be obtained at will. The coils are wound on a 2 in. diameter former, the actual winding, of course, depending upon the wavelength range which has to be covered. If a transformer arrangement is incorporated, then the primary is wound on a 1½ in. diameter former which is fitted inside the secondary. This gives a close coupling between the two windings, and has proved satisfactory in use.

A Standard Base

Various manufacturers are making and marketing these screened coils, and in order that their use may be facilitated as far as possible, it has been decided to standardise the fitting on the base of the screen. A "Southern cross" formation has been adopted, therefore, the actual layout of the pins and the connections to the terminals being as shown in the diagram in Fig 2.

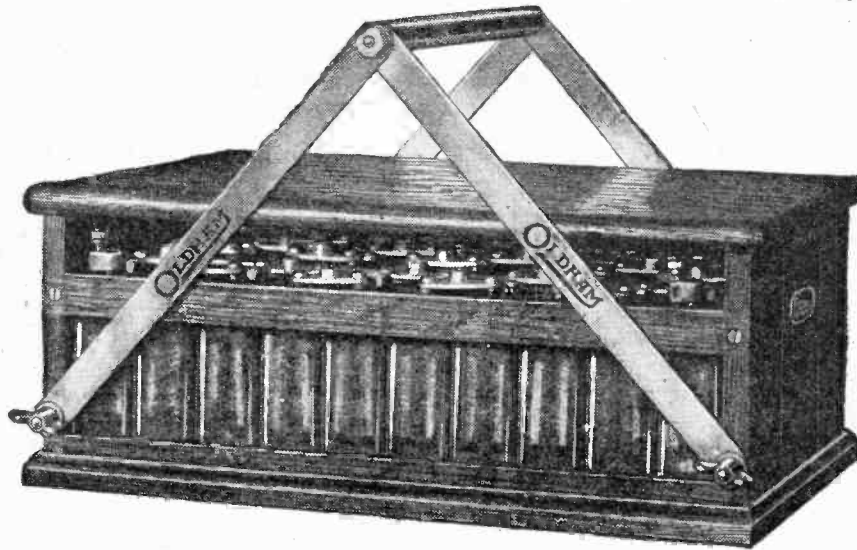

The Only High-Tension Accumulator built in units like an expanding bookcase

THE H.T. Accumulator is now added to the ever-increasing list of commodities to which the expanding system has been successfully applied. Just as the unit principle revolutionised the bookcase, so, we predict, will the new Oldham H.T. Accumulator change the whole trend of battery design.

The principle underlying this new Oldham is just this: a single unit is made up of ten 2-volt cells complete in a wooden holder; thus if a 60-volt Accumulator is wanted, three of these units are supplied clamped together, complete with carrying handle. Other units can be added at will (as illustrated on this page) to make up accumulators of 80, 100, or 120 volts.

The unit principle is, however, by no means the only advantage of this new accumulator. The fact that it bears the proven name of "Oldham" is sufficient to commend it to thousands of accumulator users whose experience tells them that the Special Activation Process, under which it is made, is responsible for a far greater efficiency,

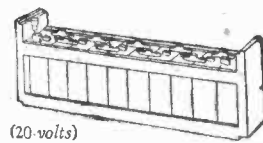

(20 volts)

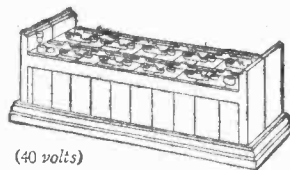

(40 volts)

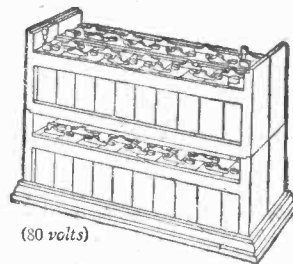

(60 volts)

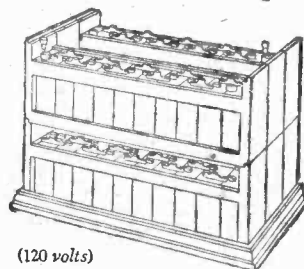

(120 volts)

immense resistance against all accumulator ills, and therefore a much longer life.

The Oldham H.T. Accumulator is not only more efficient, but is cheaper than the dry battery. Constant cost of renewals of H.T. Batteries has been a big deterrent against radio; the initial cost of this accumulator is covered in the amount saved in renewals after a few months' use. An additional feature that must not be ignored is that, each cell being tapped, the accumulator can be used for grid bias.

Finally, you should note that every Oldham Accumulator is soundly constructed to give several years' service. Each cell is a real miniature accumulator, using real plates and contained within a stout glass box, sealed at the top against evaporation. There are no cheap flimsy test tubes to break—no thin plates to buckle—no connections to corrode and cause trouble. Ask your Dealer to show you one—you'll be amazed at the moderate price of such a beautifully constructed accumulator.

10d. per volt

60 volts, £2-10-0 100 volts, £4-3-4
80 volts, £3-6-8 120 volts, £5-0-0

Complete with lid and polished aluminium handles

Solid Oak Base. 3/6 extra

Gilbert Ad 5480

Tell the Advertiser you saw it in "MODERN WIRELESS."



OLDHAM & Son, Ltd.

Denton, Manchester

LONDON: Hazlitt House,
Southampton Bldgs., W.C.2

Service Depot: 6, Eccleston Place,
S.W.1

Phone: Victoria 0286

251

HOW TO USE THE SCREENED COIL—(Continued)

By this means the coils will be readily interchangeable even if they are acquired from different manufacturers.

Practical Tests

These screened coils have been used and experimented with during

have behaved in this manner although the actual circuits tried were of an experimental nature. In other words, the use of these screened coils enables one to put theory into practice with a minimum of difficulty.

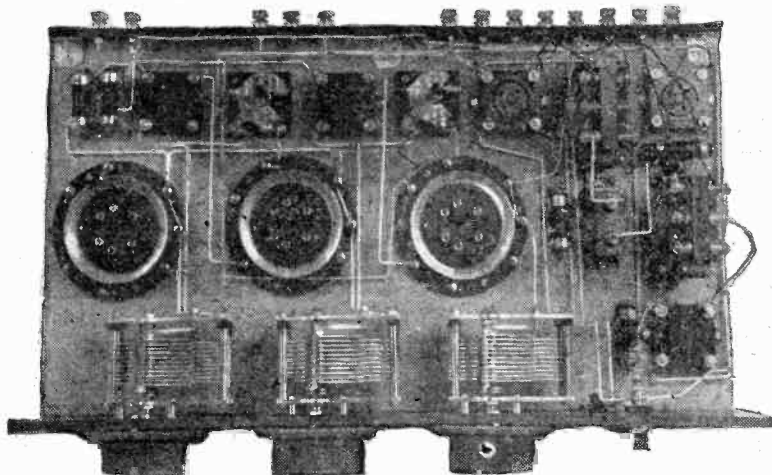

Different wave-length ranges can be obtained with the aid of suitable interchangeable coils.

the past few months with a view to discovering how they operated in actual practical receivers, and whether there were any difficulties to be overcome. Certain minor points have arisen in practice, but the general principle of the coils has remained unaltered, and very satisfactory results are obtainable. I propose in this article to discuss some of the points which cropped up during the experiments, so that those readers who have not yet used screened coils may not be troubled if they encounter any of these effects when they first experiment with the new component.

One of the most pleasing features of the arrangement is that the circuits incorporating these coils can be connected up and will work straight away. In many cases the question of the coupling between the various parts of the circuit is a matter which requires certain consideration, and it may be that trouble arises from this cause. With the screened coils all the coupling is completely under control. The transformers are made up to a definite specification so that the actual coupling between primary and secondary is fixed and definite. The last three sets which I have constructed for experimental purposes utilising these screened coils

Effects on Tuning

One point which puzzles people when they first use the coils is the change of tune which is obtained if the screen is removed. The presence of the metal shroud near the actual tuning coil reduces the effective inductance of the coil to a small extent. Consequently if the circuit is tuned in to a given station with the screen in place and the cover is then removed, the signals will vanish or at any rate decrease in strength. It will be found that the capacity of the tuning conden-

ser has to be decreased in order to bring in the signals once again.

The converse of this is also true, namely that if the circuit is tuned in with the screening cover removed, then when the screen is replaced the signals will fall off and may even vanish altogether. This is often construed as indicating a heavy loss due to the screen, but, actually a retune on the condenser will bring the signals in again.

Conversely to the previous case the capacity has to be increased when the screen is fitted over the coil. If, therefore, this effect is obtained in actual practice it should not be assumed that there is some fault in the receiver, or that the screened coils are defective, because this is quite in order and is simply due to the change in inductance imposed by the presence of the screen.



EARTH TERMINAL CONNECTED TO SCREEN

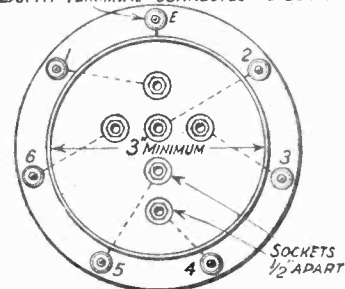

Fig. 2. The sockets in the base are placed half an inch apart.

An Important Point

Another important point is that the screen must be effectively earthed. If this is not done then the screening cases will take up some high-frequency potential and this will give rise to various undesirable effects. It may be that uncontrollable oscillation will result, but I have found the more general effect to be a lack of signal strength throughout the whole receiver. The receiver may behave in a normal manner and tune as it should do, yet there is some indefinable lack of signal strength which cannot be made up whatever one does.

If trouble of this sort is being experienced it will be found that by touching the screens themselves

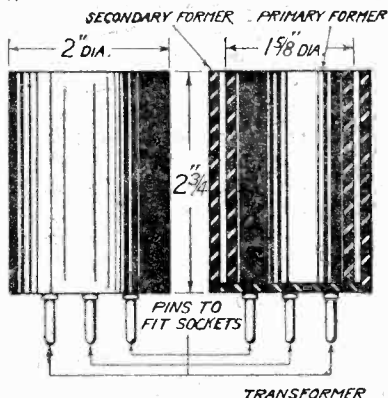

Fig. 1. The dimensions of the primary and secondary formers.

HOW TO USE THE SCREENED COIL—(Concluded)

with the hand, a change in the signal strength is obtained. If the screens are earthed of course, this should not occur and in a correctly working receiver little or no effect is noticed if the hand is placed on any one or more of the screens.

Efficient Earthing

The screening cases are made with an earth connection to the

built up by the use of suitable plug-in coils to fit the screening cases.

The point to remember, of course, is that with this type of component, once the screening case is obtained, then it is only necessary to change the inside coil, which is a comparatively easy matter. The actual price of the screens themselves is a little expensive in the

experimental period are as the following:—

1.—*Plain tapped coil.*—This is wound on a 2 in. former. For the low waves the winding consists of 90 turns of 30 D.S.C. wire spaced 40 turns per inch. Tappings are taken at 10 and 15 turns. For the Daventry range, 300 turns of 40 S.S.C. are employed, tapped at 50 and 100 turns.

2.—*Split secondary transformer.*—The secondary winding of this is carried on a 2 in. former as before, but consists of 150 turns of 30 D.S.C. wire, unspaced, with a tapping in the centre. This type of coil is designed for use with split-condenser circuits so that the coil itself is double size.

The primary consists of 20 turns of 30 D.S.C. wire wound on a 1½ in. former placed inside the secondary, the winding being in the centre of the secondary.

For the Daventry range the coils have not yet been perfected.

3.—*Split primary transformer.*—The secondary consists of 90 turns of 30 D.S.C., spaced 40 turns per inch on a 2 in. former as in the plain coil.

The primary has two windings. First is a winding of 25 turns of 30 D.S.C. on a 1½ in. former, which is used as a neutralising winding. On top of this and wound in the same direction is a further 25 turns, which constitute the primary proper. The end of the first winding is connected to the beginning of the second.

For the Daventry range the secondary consists of 300 turns of 40 S.S.C., and the two primaries each have 85 turns of 36 D.S.C.

Minor Deviations

Slight variants of these transformers and coils have also been used. For example, one coil used in the *Five-Fifteen* (described in the *Wireless Constructor* for May 1926) consisted of a main winding of 80 turns of 30 D.S.C. with a further 35 turns for a reaction winding.

The transformer used in the three-valve set in this issue also contains a reaction winding, but the general design of the coils is confined to the three classes just described.

In any case the winding details are given with the description of the receivers themselves, so that there is no difficulty in either obtaining the coils ready wound from one of the various manufacturers or in winding the coils on suitable blanks as preferred.

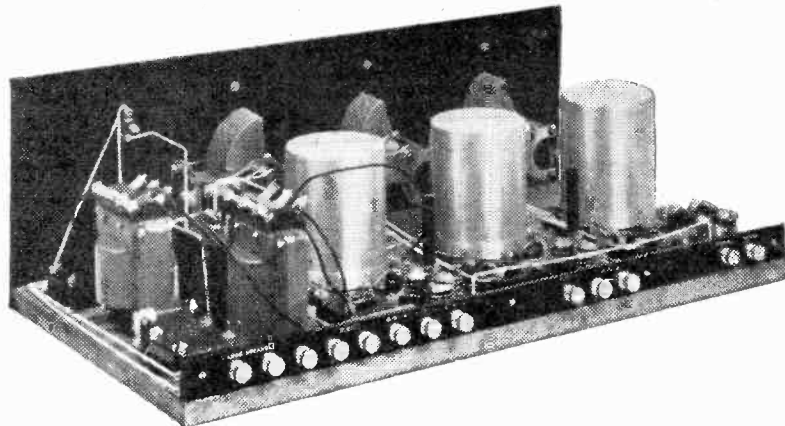

The use of screened coils permits an exceedingly compact layout.

base of the screen. The screening cover itself fits over this base, and is earthed by actual electrical contact with this base itself. I have found in certain cases that due to a loose fit or perhaps a somewhat dirty surface the proper earthing contact was not being obtained between the two sections of the screening case. The remedy in such cases, of course, is to clean up the surface slightly and to ensure that it makes good electrical contact with the base.

These points are only mentioned because they provide puzzling results, and I had a little trouble when I first encountered them. In the majority of cases these faults do not occur and no difficulty is experienced, but it is just as well to realise what is happening if troubles of this nature do occur.

Interchangeable Coils

As a result of these experiments various standard coils and transformers have been devised and these items may be obtained from all the manufacturers of the screened coils. A list of the types of transformers available is given below, from which it will be seen that a very considerable variety of circuits may be

first place, but this is an item which is incurred once and for all.

As I indicated previously in this article, there will be several sets designed during the coming season incorporating this latest addition to the art of radio reception.

Principal Types

The types of coil which have been found of most use during the

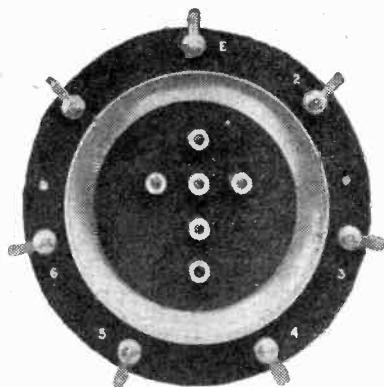

The base consists of six sockets placed in "Southern Cross" formation, the leads from which are taken to terminals. Terminal E is joined to the screen.

“WHAT ON EARTH...!”

Hunting Trouble in a Resistance Amplifier

By

JOHN UNDERDOWN

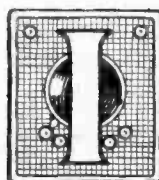

INSTEAD of dealing with a number of general faults it is intended this month mainly to detail the effects of various faults deliberately put upon a given receiver, the actual set being “My Home Set” described in last month’s issue. In arranging a number of deliberate faults in order that their symptoms might be observed, several actual ones for which I was not prepared appeared, and had to be rectified. The set had been on

set is given in Fig. 1, from which it will be observed that it is a Reinartz receiver with anode bend rectification for the detector valve, which latter is followed by two resistance-coupled note magnifiers, a filter circuit being incorporated in the plate circuit of the last valve.

Battery Values

The set was then connected up with 6-volt resistance-coupling valves for V_1 and V_2 , and a small power-valve of similar filament rating for V_3 . The high-tension supply to the detector valve was between 60 and 70 volts, and 100 volts were applied to the plates of the note magnifiers, with $1\frac{1}{2}$ volts grid bias for V_2 and 6 for V_3 . For G.B.I., that is the grid-bias battery for the detector valve, a 9-volt battery, tapped in $1\frac{1}{2}$ volt steps which had been used in a receiver

Insulation Testing

Upon the return of the receiver from Bush House and before giving it an aerial test I applied a number of insulation tests, with a 500 volt “megger” and found the insula-

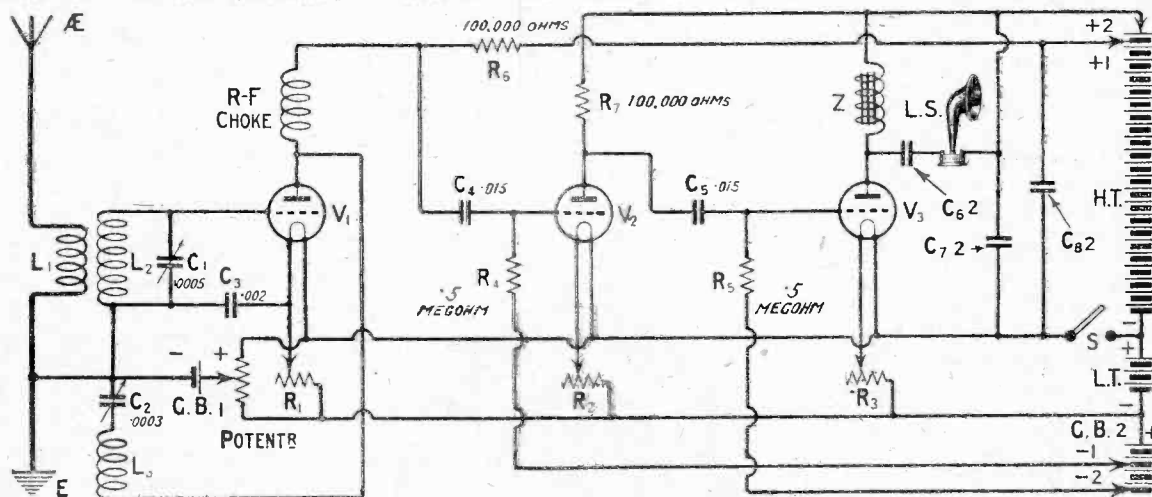

Fig. 1.—The theoretical circuit of the receiver employed by the author in investigating a number of faults.

show in Bush House, had been subjected to a thorough 24 mile shaking in a Ford lorry, and had covered about that distance by train, so it was not surprising that certain minor faults developed.

The Theoretical Circuit

For purpose of reference the theoretical circuit diagram of the

tion of all condensers in vital spots to be adequate, infinity readings being obtained, and I also tested between the grid socket and the low-tension positive and negative terminals respectively. Here again the insulation was of a satisfactory order, practically infinite resistance readings resulting throughout.

which was working at the time, was employed.

An Unexpected Fault

Aerial and earth were connected, as was the loud-speaker, and with appropriate coils in the L_1 , L_2 , L_3 and the radio-frequency choke positions, I proceeded to tune in the local station. All that could be

A GOOD CIRCUIT DESERVES THE BEST COMPONENTS

**FOR
YOUR
ELSTREE
SIX**

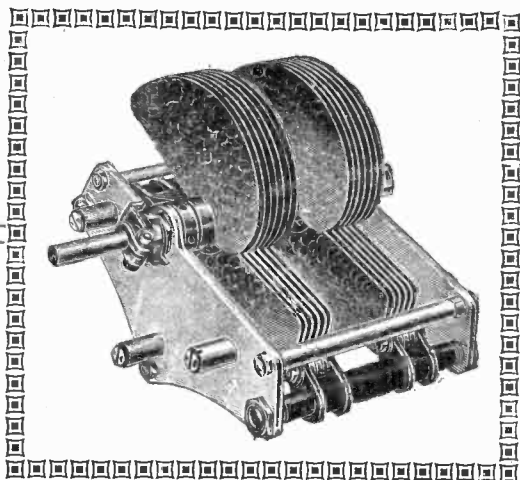

**IGRANIC
DUAL
VARIABLE
CONDENSERS**

**LOW-LOSS
SQUARE LAW
TYPE**

Patent No. 220312.

Look through your copies of "Modern Wireless" and other Radio Press Journals—notice that in practically every issue Igranitic components are used in one or more receivers with outstanding success. Proof positive of their excellence.

Igranitic Variable Condensers have extremely low electrical losses, accurate square law characteristics, combined ball and friction thrust bearings, positive connection to moving plates, accurate rated capacities with extremely small minimum.

Their mechanical construction and finish are of the highest possible standard.

The two halves of the Dual Type are closely matched.

PRICES.

Send for particulars of the new Igranitic Coils for all wavelengths from 10-25,000 metres.

**PRICES
FROM 2/6 EACH**

0003 mfd. (each section) ...	22/6
0005 mfd. " " ...	27/-
Igranitic 4 in. Combined Knob and Dial ...	2/6
Igranitic Indigraph Vernier Knob and Dial ...	7/6

The new issue of the Igranitic Radio Accessories Catalogue contains particulars of many interesting new lines and price reductions.

A copy is awaiting your request. Mention List No. J67.



149, Queen Victoria St.
LONDON.

Works:
BEDFORD.

Tell the Advertiser you saw it in "MODERN WIRELESS."

“WHAT ON EARTH . . . !”—(Continued.)

obtained, however, was a noise similar to violent atmospheric super-imposed upon a continuous bubbling note. The bubbling noise seemed indicative of a fault in one of the grid circuits, and the two plugs were therefore withdrawn from the detector grid-bias battery and telephones were connected in place of the loud-speaker. When this was done fair telephone strength was obtained from 2LO, and on reinserting the plugs, this time into a different portion of the G.B.I. battery, normal working was obtained.

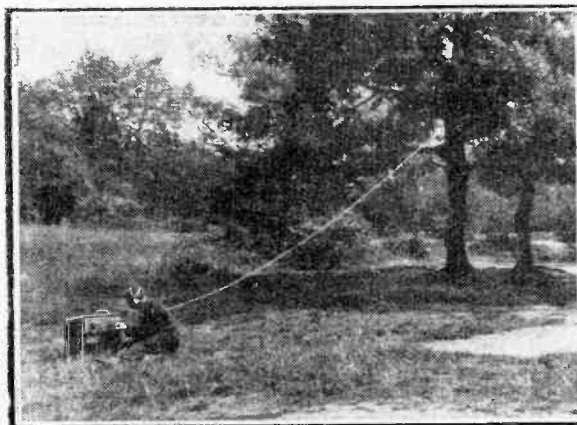

In the “Holiday Two” special attention was devoted to the wiring in order to obviate faults produced by vibration.

Fading of Signals

A fault which is sometimes experienced with resistance-coupled amplifiers is that signals gradually fade away and only switching off the set for a minute or so will allow them to return again to full strength, which is followed by a further fading. This trouble is due, in most cases, to grid leaks having developed very high resistances or having failed completely. I tried to duplicate this fault by removing the grid leaks, but although volume was considerably reduced the desired effect was not obtained, despite the

A Voltmeter Test

On testing the grid-bias battery with a high resistance voltmeter no reading was obtained across the particular cell which had originally been used for G.B.I., but the remainder of the battery, which had been used for grid bias in the other set, was found to be correct.

Faulty Resistances

The next step taken was to in-

place of R_6 , faint signals were still heard in the telephones, and on placing the first finger and thumb of one hand across the R_6 clips signals came up to practically full strength. As a matter of interest I then placed my first finger and thumb across the two output terminals of the insulation tester and turned the handle slowly, when a reading of the order of 80,000 ohms was obtained.

fact that the insulation between grid sockets of the valve and the filament wiring was shown to be adequate by the “megger.” Volume was, however, reduced. It is probable that slight leakage across the valve bases themselves prevented the amplifier from choking.

Where the signals gradually fall off, as explained above, the grid leak should be the first to receive

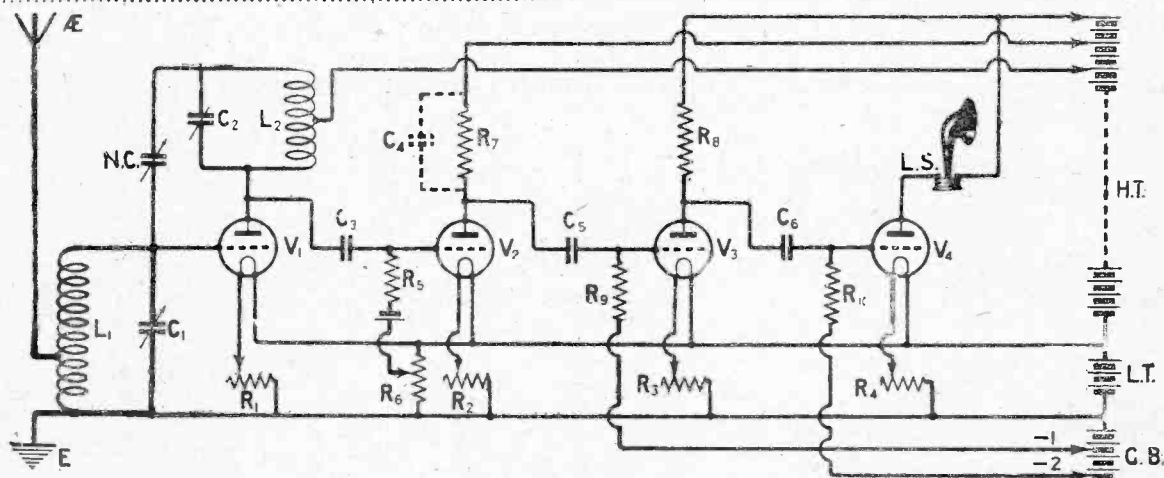

Fig. 2.—Unwanted H.F. currents, if amplified by the L.F. side, may give rise to considerable trouble.

investigate the effect of a broken-down anode resistance, one of which happened to be to hand and which on a megger test, a somewhat brutal method, showed a complete break, that is gave an infinity reading. On placing this in the anode circuit of the detector valve

On replacing R_6 and trying the defective anode resistance in the plate circuit of V_2 , slightly distorted faint signals only were heard and again on placing the finger and thumb across the clips of the R_6 holder signals came up to practically loud-speaker strength.

attention, and here values of .5 or .25 megohms generally prove suitable.

A Simple Test

Where anode resistances or grid leaks are suspected of being faulty the application of the well-known telephones and dry cell test will

APPOSITE ADAGES. No. 2.

*Never trouble
trouble!*

Specify

DUBILIER
PRODUCTS

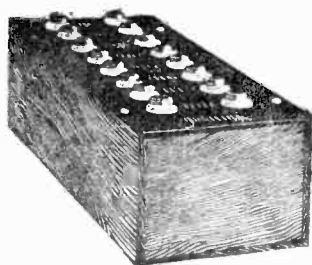

Have you entered for the
Dubilicon Competition
yet?

If not, write to us now for
full particulars.

Cash Prize £200.



ADVT. OF THE DUBILIER CONDENSER CO.
(1925) LTD., DUCON WORKS, VICTORIA ROAD,
N. ACTON, LONDON, W.3.
TELEPHONE: CHISWICK 2241-2-3.

E.P.S. 100



The Innkeeper

To the weary traveller this one-time familiar figure stood for real comfort and the best of good things. To the wireless enthusiast to-day Six-Sixty Valves stand for the best in radio reception. They enable you to command unequalled volume, and yet retain that wonderful purity of tone for which they have already become famous. And it's good to know that our new range contains just the valve you need for your particular set or circuit.

Take for instance the S.S. 7—a real Power Valve which has been recommended by all the leading Wireless Journals to-day. This valve is absolutely non-microphonic, and consumes only .1 amps filament current. Hundreds of satisfied users have expressed their appreciation of this perfect valve emphasising in the main its wonderful purity of tone and remarkable economy. We can confidently state that there is no valve on the market to-day which can boast of a longer life, because there is no valve that operates at a lower temperature.

Then there's the S.S.3 L.F. (green disc) for small or medium sized Loud Speakers. The S.S.3 (red disc) gives excellent results both as an H.F. amplifier and as a detector. Owing to the low current consumption of both types dry cells may be used.

**FOR PERFECTION OF QUALITY
insist on SIX-SIXTY VALVES.**



S.S. 7

Voltage - - 3.7 volts.

Consumption - .1 amp.

PRICE 22/6

*These prices do not apply
in the Irish Free State.*

*Leaflet S.S. 1.7
gives full particu-
lars. Your Dealer
will be pleased to
order Six - Sixty
Valves for you if
he is out of stock.*



SIX-SIXTY VALVES
Better by Six times Sixty

The Electron Co., Ltd., Triumph House, 189, Regent Street, London, W.1.

Tell the Advertiser you saw it in "MODERN WIRELESS."

“WHAT ON EARTH . . . !”—(Concluded)

sometimes throw a certain amount of useful light on the fault. If the component is completely broken down no clicks will be heard upon applying the test, but very little indication is afforded where the component has passed its useful life and has developed a high resistance.

Noisy Background

Occasionally after a considerable period of use the background obtained from a resistance-coupled amplifier will tend to become slightly noisy, a hissing sound being heard during the silent portions of the programmes. If batteries are proved, by substitution, not to be responsible for this fault, the anode resistances should be regarded with suspicion.

Coil Faults

Breakdowns in tuning or reaction coils generally give rise to some definite symptom which allows of a diagnosis being put forward. For example, if a break occurs in the reaction coil L_3 , no adjustment of the reaction condenser C_2 will produce oscillation, whilst a break in the grid coil L_2 will result in no signals being heard, and on increasing the reading of the reaction condenser to a suitable setting to give oscillation, a howl usually results.

Short-Circuited Coils

A less common fault, although one which may occur if the two ends of the coil are both brought out in close proximity, is a short-circuit. When this happens in the aerial coil no signals will be heard, nor will they if the secondary coil L_2 is shorted. In this latter case rotation of the condenser C_1 will make no difference whatever, and if this occurs the coil should be examined carefully, as a short of the type mentioned above may usually be seen by inspection.

A demonstration of the effects of vibration on soldered joints was afforded to me whilst carrying out these tests, signals dying to less than crystal strength whilst I had removed the telephones temporarily from my head. After careful

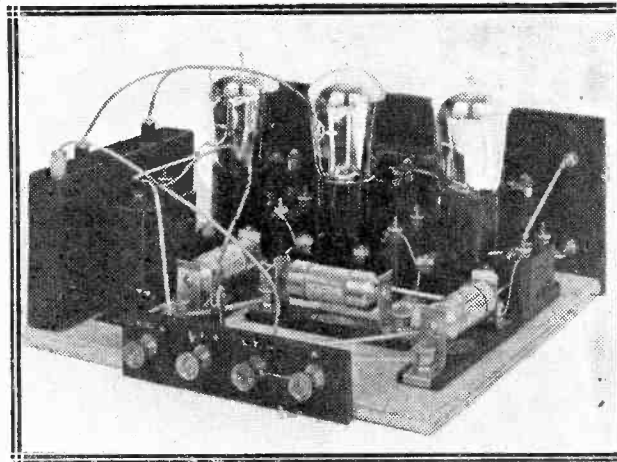

Fading of signals in a resistance amplifier is frequently produced by defective grid resistances.

searching it was found that as a result of jolting received the lead joining C_6 to the lower loud-speaker terminal had broken. For portable sets, therefore, it is advisable to dispense with soldered joints as far as possible, and to use fairly thin wire rather than stout gauge material, which is more rigid and thus more liable to be affected by vibration.

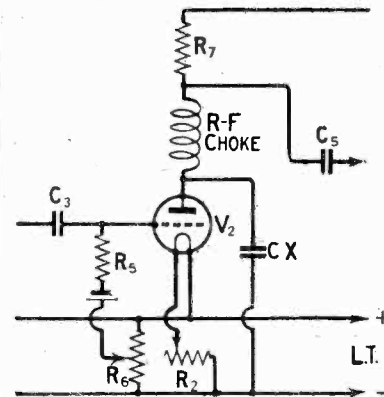

Fig. 3.—A radio-frequency choke and a suitable by-pass condenser prevent instability.

Unwanted H.F. Currents

Before leaving the subject of the functioning of resistance-coupled amplifiers, a few words of warning on the subject of unwanted H.F. currents on the L.F. side is called for. It should be realised that a resistance-coupled L.F. amplifier will act equally well in amplifying

high-frequency currents and the result, if some method of avoiding this danger is not employed, is that the receiver may become extremely unstable, difficult to handle, and reproduction may be poor. In extreme cases continuous oscillation at audio-frequency will occur.

The circuit of Fig. 2 is given to illustrate these effects. Here it will be seen that a neutralised high-frequency stage followed by a detector with anode bend rectification, and on the L.F. side two resistance-coupled note magnifiers, are shown.

Symptoms

In the plate circuit of the detector valve V_2 is the anode resistance R_7 , and in this circuit besides the rectified currents, which are required to give signals, there will be present small H.F. currents also. If these are amplified by the L.F. side the set may become so unstable as to be unmanageable, or continuous ticking or howling may be heard. The simplest method of overcoming this difficulty is to place a small fixed condenser across R_7 , as shown dotted, values of .001 to .0005 generally being suitable. A disadvantage of this remedy is, however, that the condenser will tend to by-pass the frequencies of the upper musical range to a certain extent. This, however, is not serious providing C_4 is kept within the limits mentioned above. In some cases it may exert a beneficial effect if reproduction is inclined to be “thin” through the coupling condensers C_5 and C_6 being too small or for any other reason.

A Better Remedy

A better remedy to overcome troubles arising through the introduction of H.F. currents into the L.F. side is to place a radio-frequency choke in the plate circuit of V_2 and join a by-pass condenser across the plate of the detector valve and low-tension positive or negative. The connections required are indicated in Fig. 3. In the CX position condensers of .0005 to .001 may be tried, and for the choke a No. 250 coil.

PRACTISE MORSE

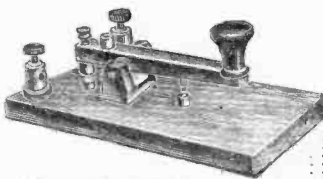

MORSE KEY

Of superior construction and finish. Recommended for every purpose where a good sturdy key is required.

RB 80/5

Price 7/6

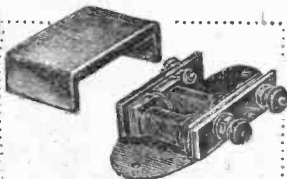

BUZZER

Fitted in neat hand finished brass cases: an adjustment is provided to give a large range of notes, and a double arm breakensures constancy.

RB 80/2

Price 3/9

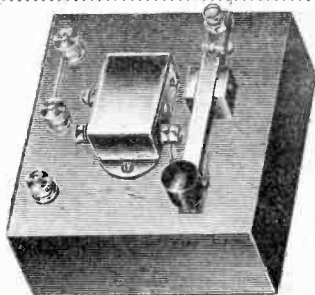

BUZZER SET

Morse Key and Buzzer mounted on well-made cabinet, underneath which room is provided to take a standard pocket lamp battery.

RB 80/1

Price 10/6

Brown Brothers Limited

~ Allied Companies ~
THOMSON AND BROWN BROTHERS LTD
BROWN BROTHERS (IRELAND) LTD

WHOLESALE ONLY.

GREAT EASTERN STREET, LONDON, E.C.2
126, George St., Edinburgh, and Branches.

Kindly order from your wireless dealer. We cannot supply direct.

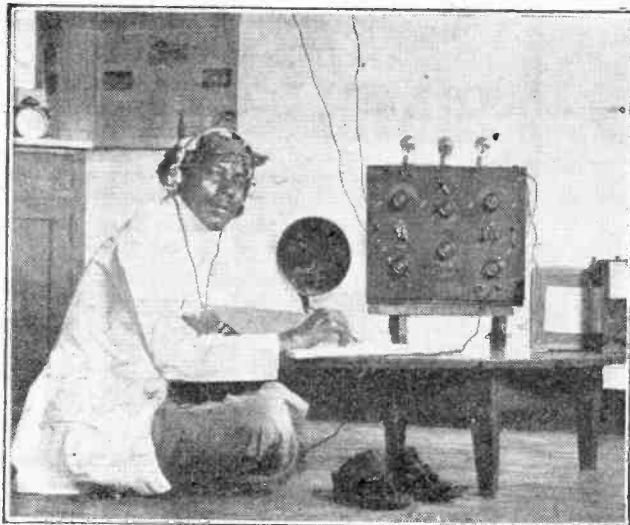

East comes West for true Radio Reproduction

IN many respects the East excels the West. Not so in Radio. That is why in many an Indian or Chinese home you'll find the **Brown**. The fame of such a superb instrument as the **Brown** was sure to spread. A Loud Speaker, upon which such care was lavished and such scrupulous pains were taken to ensure it being perfect in volume and tone, was, from the first, destined to have a world-wide popularity. The first Loud Speaker to be used for Wireless purposes in this country is now to be found rendering faithful radio-service throughout the world. There's a reason—hear the **Brown** at your nearest Dealer's, and you'll appreciate the world's preference.

There's a Brown for everyone!

Brown Loud Speakers are made in the following types—H.1, 120 ohms £5 5 0, 2,000 ohms £5 8 0, 4,000 ohms £5 10 0. H.2, 120 ohms £2 5 0, 2,000 ohms £2 8 0, 4,000 ohms £2 10 0. H.3, 2,000 ohms £3 0 0. H.4, 2,000 ohms £1 10 0. H.Q., 2,000 or 4,000 ohms £6 0 0. Type Q, 120, 2,000 or 4,000 ohms £15 15 0. Cabinet Type, 2,000 or 4,000 ohms £6 6 0, and Crystavox £6 0 0

There is also a range of **Brown** Headphones. They are priced from 20/- to 60/- Ask your dealer.



S. G. BROWN, Ltd.,

Western Avenue, North Acton, London, W.3.

Retail Showrooms—19, Mortimer Street, W.1; 15, Moorfields, Liverpool; 67, High Street, Southampton.
Wholesale Depots—2, Lansdowne Place West, Bath; Cross House, Westgate Road, Newcastle; 120, Wellington Street, Glasgow; 5-7, Godwin Street, Bradford.

G.A. 5470.

CYLDON

(Pronounced SIL-DON)

.0005 SQUARE LAW

Dual Condensers

as used by the designers of the "Elstree Six."

Their unvarying smoothness and ease of action is due to the accurately grounded Rotor.

Price: 27/6 each. Set of four, £5 10s.

Send for full particulars of

TEMPRYTES

(Regd. Trade Mark) the perfect control for all Valve Filaments. Manufactured in values to suit all valves. From .3 to .55 ohms. 2/6 each. Holder Mounting for Temp-rytes 1/6 each.

Cyldon Condensers from your dealer or post free from makers.

Sydney S. BIRD & Sons, "Cyldon Works," Sarnefield Rd., Enfield Town, Middlesex.
TELEPHONE: ENFIELD 672.

Other "CYLDON" Condensers. SQUARE LAW.

.001	Mfds.	..	21/-
.0005	"	..	17/6
.0003	"	..	16/6
.00025	"	..	16/-
.0002	"	..	15/6
(Prices include 4 in. Knob Dial.)			
S. L. F.			
.0005	Mfds.	..	15/6
.00035	"	..	15/-
.00025	"	..	14/6

4 in. Knob Dial as supplied with Square Law Condenser, 2/- extra.

Tell the Advertiser you saw it in "MODERN WIRELESS."

SIMPLICITY WHYS AND WHEREFORES

By
PERCY W. HARRIS, M.I.R.E.



Development in receiving set design is tending towards the single control multi-valve receiver, and in this article Mr. Harris points out some recent steps towards greater simplicity.



It does not seem very long ago since I stood in front of a glittering new wireless receiver, manufactured by a then well-known firm, while the designer expatiated upon its many novelties and good points. If I remember right, there were 24 separate and distinct knobs, and there probably would have been more if space could have been found for them. There were separate filament resistances for each valve, two variable condensers for each tuned circuit, variable couplings between a tuned aerial circuit and a tuned grid circuit, variable reaction coupling between the anode and reaction coils, multi-point switches for varying the aerial inductance, multi-point switches for varying the grid inductance, switches to cut in and out various turns on two different anode coils, switches for changing from reaction on the aerial to reaction on the tuned anode, switches for cutting in and out the low frequency valves, switches for changing from telephones to loud-speaker, and goodness knows what else besides. There were five valves, each taking very nearly an ampere, while the wavelength range, in accordance with the fashion of the time, covered from about 400 to 3,000 metres.

Dutch Concerts

There was little telephony other than the "Dutch concerts," a programme broadcast twice a week from a station in The Hague, Holland, and every self-respecting wireless enthusiast in those days was able to read Morse. Spark stations, well known to all of us—North Foreland, Niton, the Lizard, Norddeich, Ushant, Cadiz, and the rest—were put through their paces for my benefit, and somewhere about 8

the word were ever mentioned in connection with telephony; and in any case, once you had recognised the transmission and tested its strength there was no great point in remaining on that adjustment. It was so fascinating to twiddle those 24 knobs, even if the demonstrator did look a little anxious at times.

A Past Era

I was reminded of the night when we tried that 24-knob receiver by seeing one of the models reposing disconsolately in a window of a second-hand shop—its panel faded to a dirty green, its brass very much tarnished and dust and scratches marring the erstwhile brilliance of its french polish. Even in the short history of wireless it represents



Matched condenser dials are a great help in tuning.

o'clock the familiar tones of the announcer on the 1,050 metre Dutch transmission made themselves heard through one of the first models of the new Amplion loud-speaker.

Poor Reproduction

Judged by present-day standards, the quality of reproduction was thoroughly bad. In any case the strength of the transmission from The Hague was so feeble that the utmost limit of reaction amplification had to be used to get recognisable speech. Strangely enough, we did not worry about quality—even if

a past era—the day when complications in a receiver were looked upon as a virtue and when one had to serve quite a serious apprenticeship before one could be trusted to handle any wireless receiver. Wireless sets of to-day are far simpler in design. No instrument with anything approaching that number of knobs could stand a ghost of a chance in the market to-day; even the home constructor, who is generally keenly interested in radio as a hobby as well as a means of obtaining music, seeks ever for simplicity, while manufacturers are

SIMPLICITY WHYS AND WHEREFORES (Continued)

wisely driving after efficiency with one knob control.

Simplicity

Have we really lost anything by abolishing the multiplicity of controls? I doubt it. Yet many home constructors still hanker after complications in the fond, if misguided, belief that such "refinements" will help them to gain efficiency. To talk of this hankering, I am venturing to discuss a few points relating to simplicity in an endeavour to show the real virtues of simplicity in set designs.

Multi-Valves

Let us analyse a multi-valve receiver into its essentials. First of all, we have the aerial circuit and its connections (for the receiver can be considered apart from the aerial with which it is used), then we have the first grid circuit with its accompanying valve, a means of coupling to the next grid circuit with the second valve, and if we consider a five-valve set of conventional design a further coupling to a detector valve with its condenser and grid leak and perhaps a couple of audio-frequency stages. We have batteries to supply the filament current and anode current respectively and means of bringing the aerial and other tuned circuits into resonance with the wave we want to receive.

Aperiodic Coupling

Now the receiver to which I have referred in my opening remarks had a tuned aerial circuit, loosely and variably coupled to a tuned grid circuit. Such an arrangement is very rare nowadays. It has been found by numerous experimenters that the aerial circuit need have no separate tuning devices of its own, provided the coupling with the first grid circuit is correct. When this is so, the tuning of the aerial and first grid circuit requires but one control—*i.e.*, that of the variable condenser which controls the resonant frequency of the grid circuit. Coupling between the aerial coil and the grid coil is either direct or

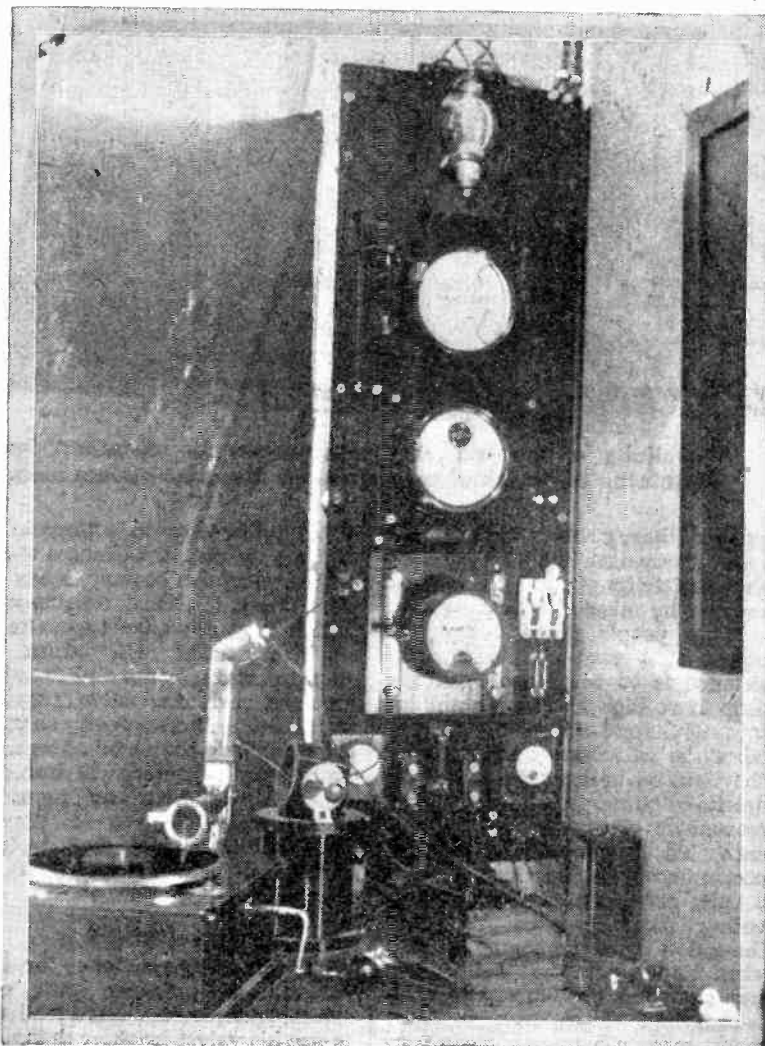

At one time nearly all the telephony to be heard came from The Hague, of which the photograph shows some of the modern transmitting gear.

indirect. Direct when a tapping is taken on the grid coil, the bottom of which is earthed, and indirect when a coil of fixed inductance is coupled to the grid inductance.

Equal Signal Strength

In neither case is it necessary to make variation of coupling save when one desires to cover a very wide wavelength range, whereas in the older arrangement, before a station could be tuned in the two separate and distinct tuned circuits had to be adjusted, and the coupling between them in addition, any variation in coupling generally upsetting the tuning of one or both of the circuits. Signal strength with the new arrangement seems just as good with the older, although the selectivity could be made better on

the older arrangement. Here, then, first of all, without any appreciable loss of efficiency we substitute one control for three.

Filament Resistances

Strangely enough, the variable filament resistance is only just departing from the front panels of both home-constructed and factory-built receivers, abdicating in favour of the fixed resistance placed out of the way behind the panel. Even to-day many set manufacturers provide a separate knob for the variable filament resistances for each valve as a matter of course without giving the matter much thought. In the hands of the skilled, a variable filament resistance is in my opinion unnecessary, while the unskilled user—and the great ma-

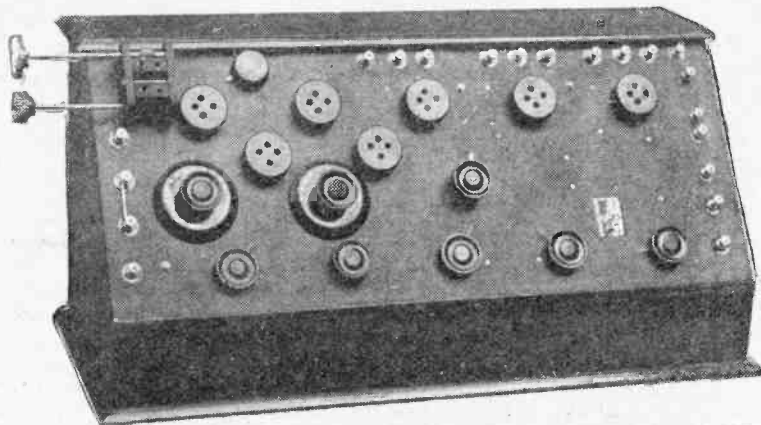

Simplicity of control may sometimes be obtained by combining the work of two or three filament resistances.

majority of those who buy factory-built receivers are unskilled—may destroy the sensitivity of his valves in an evening by misuse of these knobs.

Many people imagine that the object of a variable filament resistance is to compensate for the drop in voltage of the accumulator towards the end of its charge, so that when the valves start to grow dim they can be brought up to the requisite brightness again by a small movement of the filament resistance. They entirely forget that an accumulator will continue to give 2 volts per cell and maintain this voltage constant until practically the end of its useful charge, so that when filaments become dull it is a sure sign that the battery requires re-charging. If we now re-adjust the filament resistances to compen-

sate for the drop in voltage in the battery, we are, ten chances to one, discharging the battery below the safe point. A fixed resistance, of which there are several types already on the market, will adjust the filament current once and for all to suit the particular valve, provided the accumulator is properly charged. At the end of the useful charge, the voltage of the battery will drop, and this is indicated by a dulling of the valves and a decrease of signals. The battery should now be disconnected from the set and re-charged.

Over-Running

The unskilled user and, for that matter, the amateur with considerable experience, has a tendency to run his valves brighter than need

SIMPLICITY WHYS AND WHEREFORES (Continued)

be, for there is generally no indication on the panel as to how far the knob should be turned round to reach the correct point. Bright emitter valves will have a very short life if they are regularly run too brightly, and an increase of only 20 per cent. in filament current may reduce the life of the valve to a third of its normal figure. In the case of dull-emitter valves, particularly those of the .06 ampere type, the sensitivity of the filament can be rapidly destroyed by over-burning.

Dry Batteries

A variable filament resistance is, however, of use in a set which is run off dry batteries, as the discharge of such batteries is not maintained at a fairly constant voltage, as is the case with an accumulator, the dry battery discharge curve showing a steady falling off in voltage throughout its life. This means that a fixed resistance is unsuitable in such cases, and a variable resistance is really essential if the valves are to be kept burning at the correct temperature throughout the useful life of the dry batteries. In all cases where accumulators are used as a filament supply, the fixed resistance

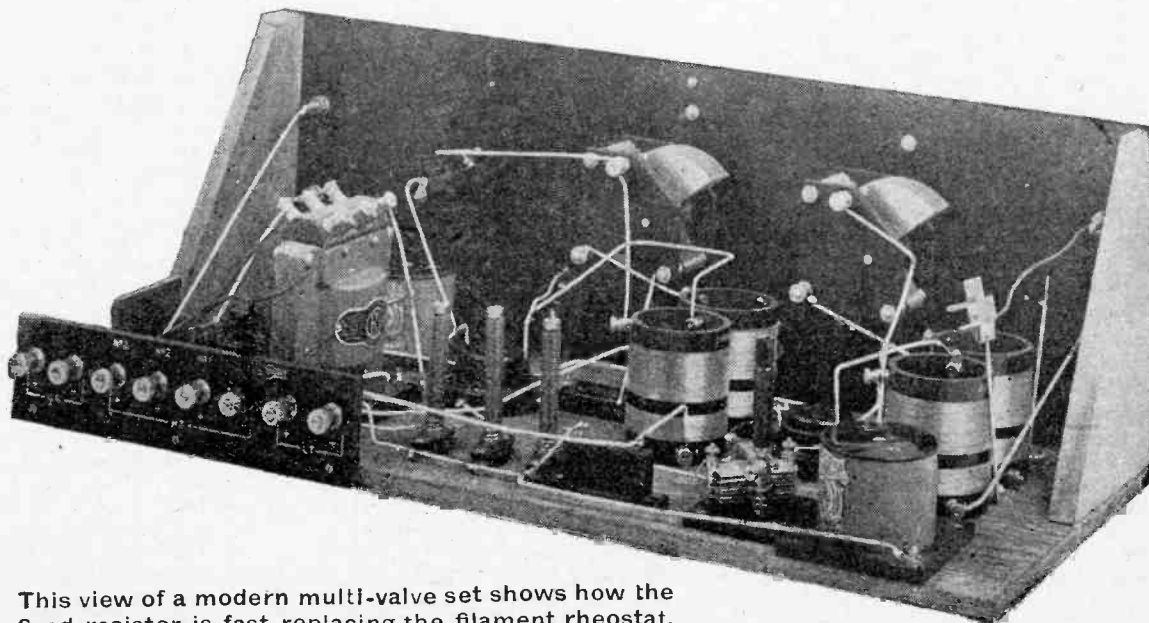

This view of a modern multi-valve set shows how the fixed resistor is fast replacing the filament rheostat.

SIMPLICITY WHYS AND WHEREFORES

will give just as high efficiency as the variable type.

Switches

The practical abolition of the tuned aerial circuit has removed the necessity for series-parallel switches, switches for changing from direct to indirect coupling and other gadgets which were at one time prime favourites. Potentiometers, which for long were the only practical means of getting stability in high-frequency circuits, are now rapidly giving way to neutralising arrangements which can be adjusted once and for all for particular valves and coils. Thus passes one more knob from the front of the set.

Switches which change over from one form of reaction to another are rarely found save in special experimental sets, while the complications of wiring necessary when switches for cutting out the note-magnifying valve have been made unnecessary by the popularising of plugs and jacks.

Plugs and Jacks

Where the same high-tension voltage is used on all valves, a fairly simple switching means can be devised, but where, as is so frequently the case, different voltages are used on various valves, the plug and jack method is the only one which does not make complicated



Fixed resistors are both neat and easily changed.

wiring. Switching on the high-frequency side is extremely difficult to arrange if efficiency is not to be lost, particularly in circuits where stray capacities have been neutralised, as is the case with very many modern receivers.

Identical Readings

A further simplification of receivers is proceeding along the lines of matching condenser readings, so that two or more condensers can be operated from the same knob. Extraordinary accuracy of manufacture in condensers and coils is required for this to be effected, and only components of the highest grade prove satisfactory.

Conclusion

To summarise: the elimination of multiplicity of control invariably leads to simplification of wiring and simplification of wiring is in its turn accompanied by an increase of efficiency. Many of the adjustments once so popular have proved to be unnecessary and real low-loss construction is in fact impossible with a multiplicity of switches. The set of the future will undoubtedly be of the one control variety, while the valves or other equivalent relay devices will obtain the energy to run them from the electric light mains.

DESIGNED SPECIFICALLY FOR BUILDERS OF THE "ELSTREE SIX"

So that the countless experimenters who invariably prefer to use J.B. Condensers in all their receivers may incorporate them in the "Elstree Six," we announce the introduction of .0005 J.B. Low Loss Twin Condenser.

The design adheres to the type here illustrated (.02 ohms loss at a million cycles certified by the N.P.L.) in addition to the other essential features which characterise the J.B. to give the utmost tuning efficiency.

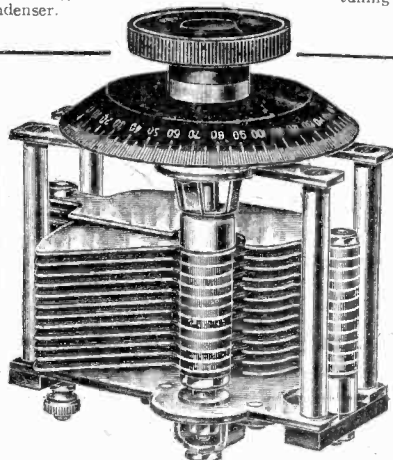

J.B. LOW LOSS GEARED VERNIER (60 to 1).

- .001 - 17/8
- .00075 - 16/3
- .0005 - 15/-
- .0003 - 13/6
- .00025 - 13/3
- .0002 - 13/-
- .0001 - 12/-

[Pat. No. 246009].

J. B. LOW LOSS.

- .001 - 13/-
- .00075 - 11/0
- .0005 - 10/8
- .0003 - 9/-
- .00025 - 8/0
- .0002 - 8/8
- .0001 - 8/3

Pat. Nos. 241805 and 246009

J.B. Low Loss Twin Condenser for the "Elstree Six" (.0005 mfd. each half.) 21/- each; £4 for the set of four.

JACKSON BROS.
8, POLAND ST - OXFORD ST
LONDON - W.1
(First Floor)
Telephone - GERARD 7414

Agents for Holland: Radio Beurs, Papestreat 8, Sgavenage, Hague, Holland

Simple, accurate, and easily adjusted

Moving block cannot fall

Don't experiment! Get a "Lotus" and be certain of better results.

The vernier movement comprises three sets of enclosed precision machine cut gears and reduces the speed of the moving coil block by eight times.

The moving block moves in the same direction as the knob, which prevents confusion. It also becomes absolutely rigid in any position holding the heaviest coil securely. No screws, required to tighten it.

LOTUS

VERNIER COIL HOLDERS

From all Radio Dealers.

Two types:

- For outside panel mounting:
 - Two-way ... 7/-
 - Three-way ... 10/6
- For inside baseboard mounting, with 6 in. handle:
 - Two-way ... 8/-
 - Three-way ... 12/6

Garnett, Whiteley & Co., Ltd.,

Lotus Works, Broadgreen Road, Liverpool

Makers of the new improved "LOTUS" Valve Holder.

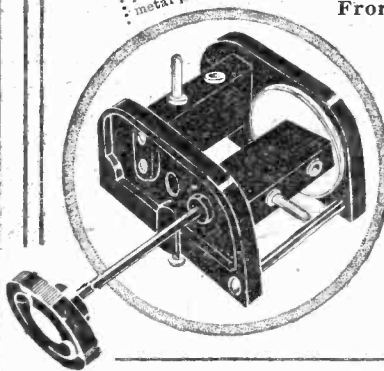

Bakelite mouldings for the side plates, coil blocks and knob: heavy nickel plating for the metal parts

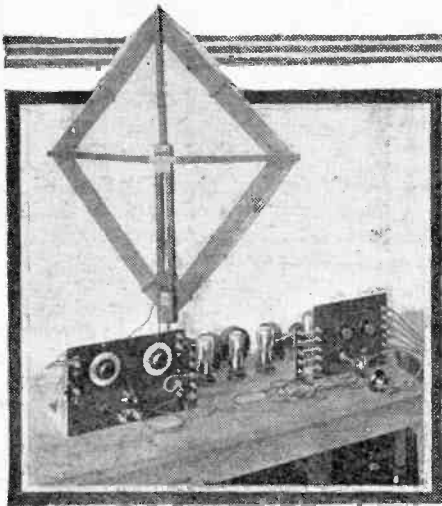

VITAL PROBLEMS IN SUPERHETERODYNE DESIGN

By
C.P. ALLINSON, A.M.I.R.E.

In this interesting article the author gives many helpful hints which the superhet. enthusiast will find of great assistance in clearing up hitherto puzzling points in the construction of this type of receiver.

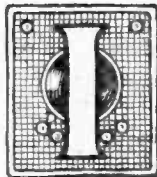

THINK that no one will deny that for the flat dweller who is perforce restricted to an inside aerial, and who wishes to enjoy the reception on the loud-speaker of stations other than his local one, the super-heterodyne receiver is at present the set *par excellence*.

It is not intended here to enter into a discussion of the merits or demerits of the super-het., but rather to deal with some of the points that require consideration and the difficulties that crop up in the construction of this type of receiver.

The Oscillator System

To my mind one of the first points to consider is the oscillator system. Is a separate oscillator to be used or should the autodyne (sometimes known as the Tropadyne) system be employed? Where space and weight are to be kept down, as in a portable set, then the autodyne is certainly to be recommended, but for conditions where a valve more or less does not make much odds I am in favour of the separate oscillator every time.

A couple of diagrams will be of help in setting forth my reasons for this preference. Fig. 1 shows a Tropadyne circuit in which the first detector and oscillator functions are combined in one valve. The frame aerial is shown as an inductance L_1 tuned by a variable condenser C_1 while the centre-tapped coil used with this circuit is shown

at L_2 , L_3 provides the reaction for the circuit $L_2 C_2$ by virtue of which it oscillates.

An Exact Centre Point

It is important that the circuit $L_1 C_1$ be connected to the centre point of L_2 if the tuning of the two circuits is to be entirely independent, this centre point of course being the nodal point of the induc-

tain amount of reaction is introduced into the frame aerial circuit which results in an increase in signal strength.

Practical Values

When the Tropadyne circuit originally appeared the value of the grid leak R_2 was given as $\frac{1}{2}$ to 2 megohms, but with this value it was found that at the lower settings

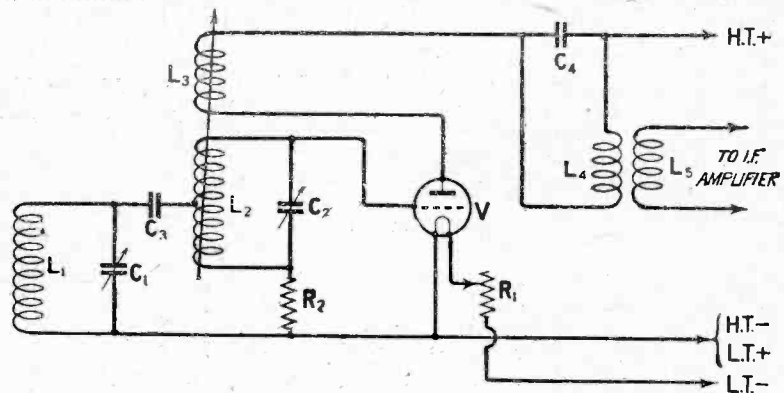

Fig. 1.—In the well-known Tropadyne arrangement one valve performs the functions of first detector and oscillator.

tance. If, however, the centre point (to employ an Irishism) is not at the centre, a transfer of energy can take place between the two tuned circuits. This results firstly in the oscillator going out of oscillation when the two circuits are brought in tune with each other, and secondly in a certain amount of interdependence between the settings of the two tuning condensers. On the other hand a cer-

of C_2 the circuit tended to squeal. Since then it has been found that the substitution of a 100,000 ohm resistance not only eliminates this squealing but also in many cases results in an increase of signal strength.

For using this circuit on broadcast wavelengths the following values would be suitable, frame aerial L_1 equivalent to No. 50 coil, L_2 centre tapped No. 50 coil, L_3 a

VITAL PROBLEMS IN SUPERHETERODYNE DESIGN—(Contd.)

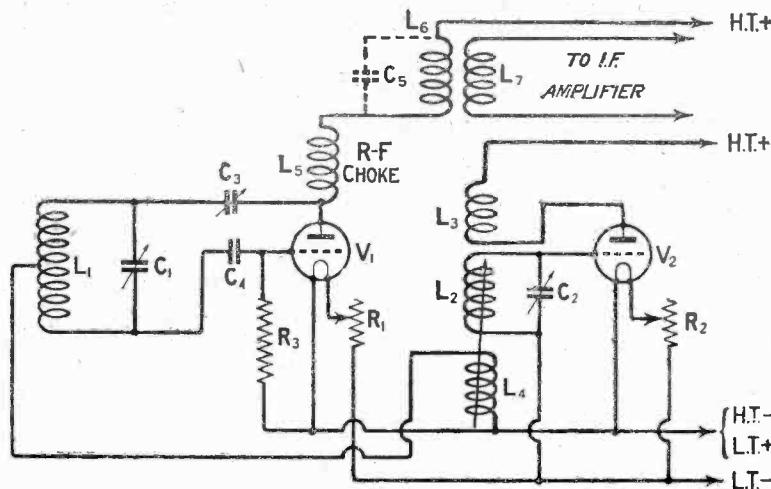
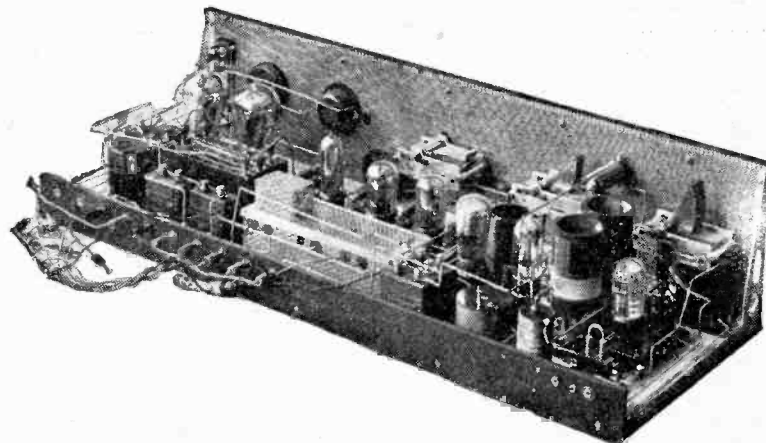

Fig. 2.—The separate oscillator method, although necessitating an extra valve, is both simple and reliable. The small condenser C_3 provides the reaction effect and increases the sensitivity of the receiver as a whole.

No. 35 coil, C_1 and C_2 .0005 each, C_3 .0003 R_1 to suit valve, R_2 100,000 ohms. The primary of the input transformer L_1 L_5 must be shunted by a fixed condenser C_4 , which may be as low as .0002.

A Separate Oscillator

A separate oscillator circuit is shown in Fig. 2, the oscillator being coupled to the detector circuit by a small coupling coil. The great advantages of this circuit, which I think most certainly justify the extra expense, are that reaction can be obtained in the first detector circuit, and that the tuning controls are entirely independent. The



added range and volume given by the use of reaction is quite marked, while the sharpness of tuning of the frame aerial is greatly enhanced.

Reaction Control

Reinartz reaction is used, and if it should be necessary to tune the primary of the input transformer with a fixed condenser C_5 , as shown in dotted lines, an H.F. choke L_5 will be required. Where the primary of the input transformer is left untuned however this choke will probably be found to be unnecessary.

Suitable values for this circuit would be as follows:—Frame aerial L_1 equivalent to No. 50 coil, L_2 a No. 50 coil, L_3 a No. 35 coil, L_4 an 8-turn coil, L_5 if required an H.F. choke or 250 coil, C_1 and C_2 .0005, C_3 .0001, C_4 .0003, C_5 as specified by the makers of the

An experimental superheterodyne employed by the author utilising fieldless coils on the H.F. side. Note the metal screening.

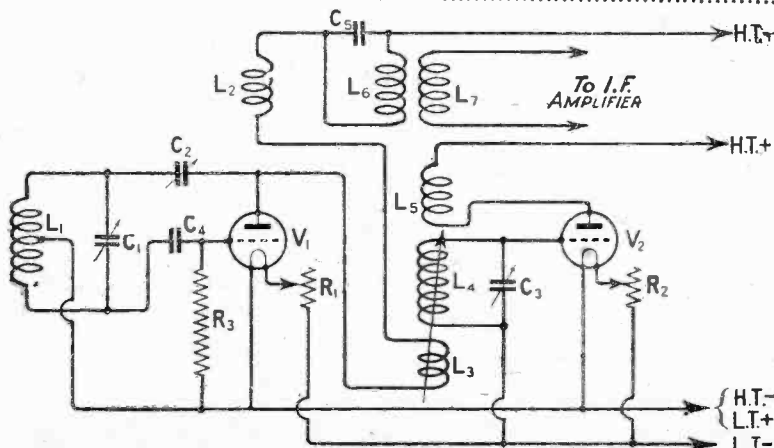

Fig. 3.—A modification of the Fig. 2 circuit in which the "pick-up" coil is connected in the anode circuit of the first detector valve V_1 .

transformer, R_1 and R_2 to suit valves, R_3 $\frac{1}{2}$ to 2 megohms.

Alternative Methods

Alternative methods of coupling the oscillator are shown in Figs. 3 and 4. In the first of these the oscillator is coupled to the anode circuit of the detector valve with the object of decreasing radiation, while in Fig. 4 a form of capacitive coupling is employed, the value of the coupling condenser C_6 and the resistance R_4 being .0003 to .006 and 80,000 to 120,000 ohms respectively.

VITAL PROBLEMS IN SUPERHETERODYNE DESIGN—(Contd.)

The Intermediate Stages

The next question concerns the intermediate frequency amplifier, and this is largely a matter of per-

to be applied to the grids of the intermediate-frequency amplifying valves so that the extra amplification obtained from the third stage

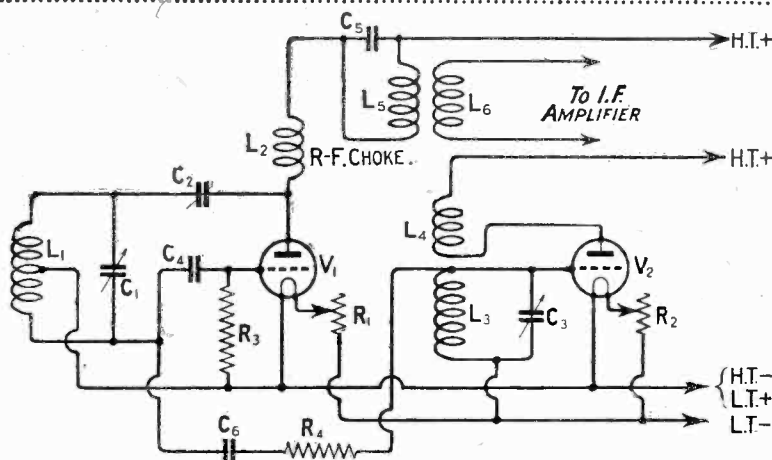

Fig. 4.—In this case the "pick-up" coil is replaced by a fixed condenser C_1 and a series resistance R_3 .

sonal choice as to what particular make is to be employed. I myself prefer the use of two stages only. Satisfactory results with only two stages will generally be obtained

is lost. Some makes of transformer—for instance, the Silver-Marshall—only allow for two stages although two of the transformers are fairly broadly tuned.

either leaky grid condenser or anode bend rectification, and many prefer the latter on account of the added purity and also selectivity that is claimed for it. There is also a third scheme that may be employed, namely, the Prince circuit, for the second detector and first L.F. This gives a very satisfactory degree of amplification, and, of course, a very high order of purity of reproduction. The extremely natural tone obtained with this circuit is indeed most noticeable.

The L.F. Side

With the first two methods the detector may be followed either by resistance or choke-capacity coupled L.F. or transformer coupling, and this again is a matter for the constructor's personal inclination. A satisfactory compromise, where two stages of L.F. are to be used, is to make the first stage transformer coupled and the second resistance-capacity, which enables a good degree of volume as well as quality to be obtained. Care must be taken of course in the choice of the anode resistance as it will probably have to deal with a fairly heavy load.

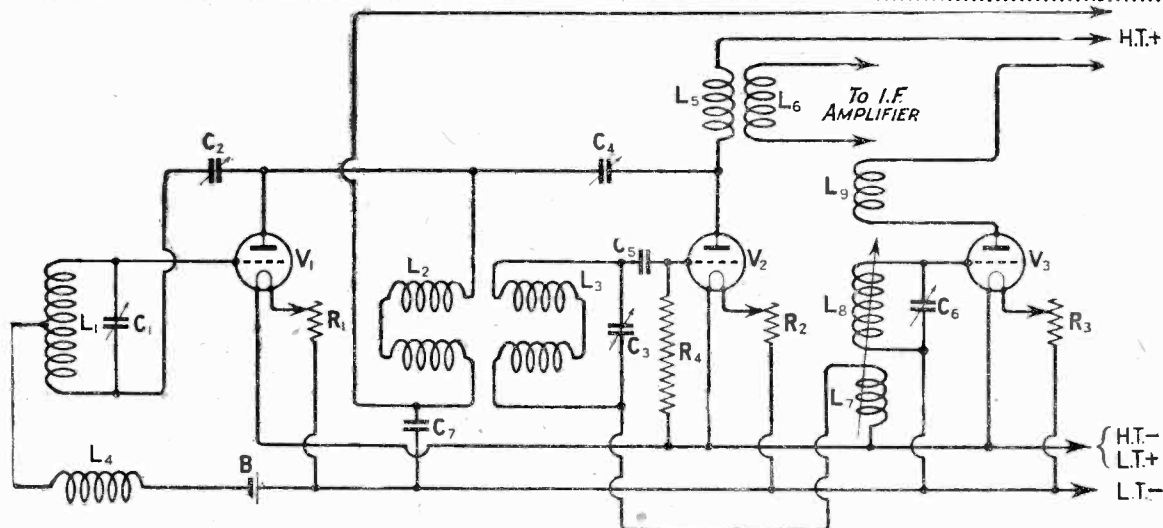

Fig. 5.—The author has obtained very promising results with an H.F. stage preceding the first detector. The above circuit, in which "fieldless" coil coupling is used, has been found to be very successful.

with any type of transformer that is somewhat sharply tuned, in which case it will be found that two stages will oscillate fairly readily. If three stages are employed the tendency to oscillate is so much greater that considerable positive bias may need

The Second Detector

Next in order we may consider the second detector and the L.F. side of the receiver. There are many arrangements that can be used. The detector may employ

An H.F. Stage

We now come to what is an important point. Shall a stage of H.F. be employed preceding the first detector? Where the cost of the extra apparatus and inclusion

VITAL PROBLEMS IN SUPER-HETERODYNE DESIGN—(Concluded.)

of an extra control do not veto this addition the answer to the question, in my opinion, is an emphatic "Yes." Especially does this apply in the case of a receiver which uses the tropadyne circuit, for the H.F. stage enables regeneration to be introduced.

Advantages

The advantages to be gained by the use of a preliminary stage of H.F. are, briefly, practically complete elimination of second channel interference and long wave pick up, improvement in range, selectivity and background.

Methods to Use

The chief considerations as to the methods to employ in adding H.F. to a superhet are what circuit shall be used, and what components shall

and leaky grid condenser rectification is shown. A simplified form of Reinartz reaction is indicated, the reaction condenser being shown at C_4 . By this scheme the coil in the anode of the H.F. valve not only acts as the primary of the H.F. coupling transformer, but also as the reaction coil, an arrangement which provides a very smooth and easy control of reaction.

The photograph on page 265 shows an experimental model of an eight valve superheterodyne in which fieldless coils are used for the H.F. stage. They can be seen on the right hand side, while the small neutralising condenser mounted on the panel is used for reaction.

A Marked Advantage

The use of these fieldless coils was found to give a marked advantage

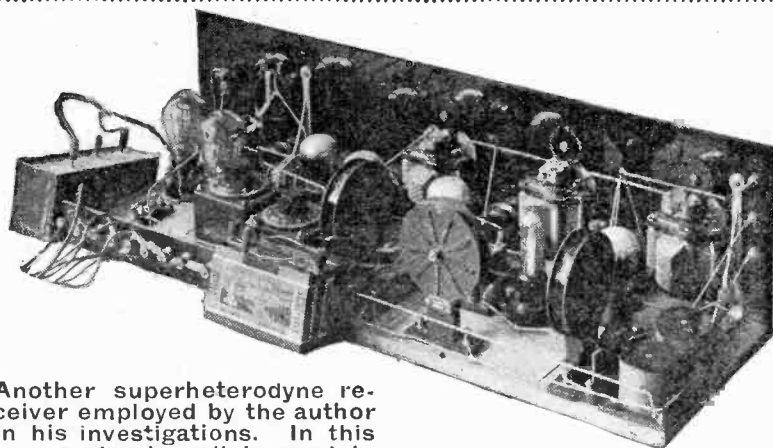

Another superheterodyne receiver employed by the author in his investigations. In this case a plug-in coil is used in the preliminary H.F. stage.

be employed. The circuit that I myself prefer is shown in Fig. 5, which shows the first three valves only of the receiver, the remainder being omitted for clearness.

It will be seen that the split grid coil type of neutralised circuit is used, only instead of the centre tap going direct to L.T.—an H.F. choke is placed in series as seen at L_4 . The inductance L_1 represents a frame aerial, the whole of which is tuned by a variable condenser C_1 . One end is connected to grid and the other through a small variable condenser C_2 to the anode.

Fieldless Coils

H.F. transformer coupling is used, fieldless coils being employed as indicated in the circuit diagram at L_2 and L_3 . The secondary is tuned

inasmuch as stray coupling between them and the frame aerial was practically eliminated. With ordinary inductances it was found that when the frame aerial was swung for direction the variation of its coupling with the H.F. side of the receiver resulted in a variation of reaction which required resetting every time the direction of the frame was altered. Also unwanted coupling with the oscillator was obviated which might otherwise have produced undesirable effects.

Suitable values for this circuit are: L_1 as before, L_2 and L_3 equivalent to No. 50 coil, oscillator and pick-up coils as before, L_4 H.F. choke or No. 250 coil, C_1 and C_2 .0005, C_3 .0001, C_4 .0003, C_5 a by-pass condenser, .002 to .006, B_1 1½ to 3 volts according to valve and H.T. used.

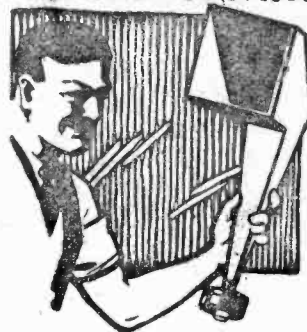

This week-end build your own loud speaker!

First of all go to your dealer and satisfy yourself that the "Lissenola," costing only 13/6, really is fully equal in power and tone to any loud speaker on the market. Ask your Dealer to put on the best loud speaker he has in stock—then use the same horn on the "Lissenola" and see if you can notice any difference.

When you get the "Lissenola" home you can build a horn yourself for a few pence, providing you with a powerful instrument which will compare with any expensive loud speaker you have ever heard. Or, if you prefer a cone-principle diaphragm—very simply made—you should get a Lissen Reed as well (1/- extra). If you have never heard a "Lissenola" there's a surprise in store for you.

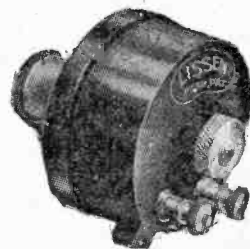

Before buying ask your dealer to demonstrate the **LISSENOLA**

LISSEN LIMITED,
20-24, Friars Lane,
Richmond, Surrey.

Managing Director: T. N. COLE. L-36

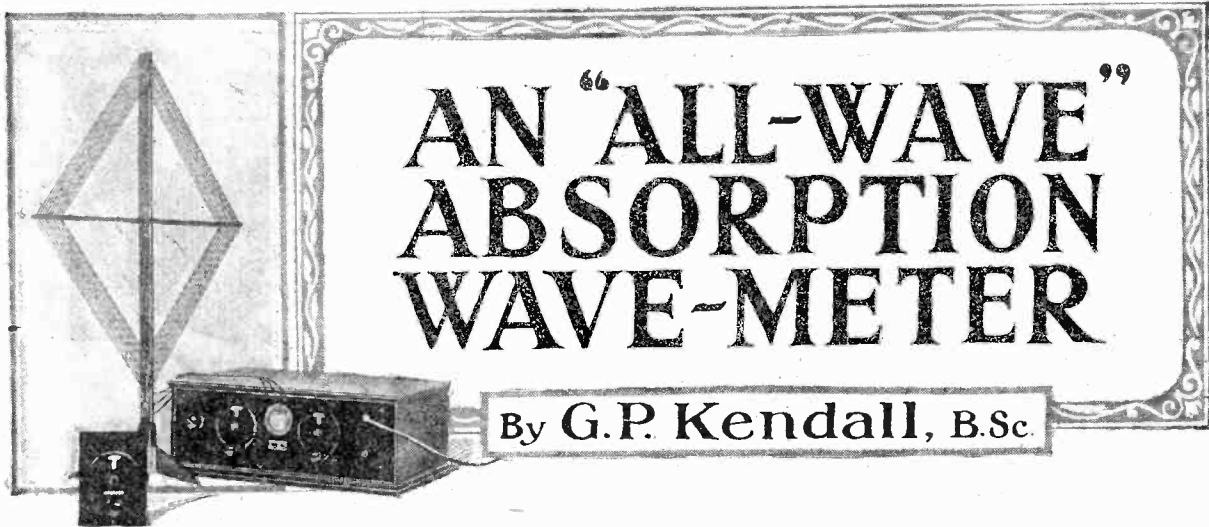

AN "ALL-WAVE" ABSORPTION WAVE-METER

By G.P. Kendall, B.Sc.

Wavemeters are a useful adjunct to any receiving set, and the one described in this issue is both simple to construct and easy to use, and is particularly suitable for employment with superheterodyne receivers, and on the short waves.



LETTER was recently published in MODERN WIRELESS from a reader who had made up the "Open Air" super-

heterodyne described by myself in the May issue, and who had experienced difficulty in using a heterodyne-type of wavemeter with this instrument. He discovered that all sorts of false readings were obtained, which mostly resulted from beats being formed between the wavemeter oscillator and the oscillating valve in the superheterodyne, in addition to the correct one obtained between the incoming signal in the frame circuit and the wavemeter oscillations.

Wavemeter Difficulties

This difficulty is a very real one in superheterodyne work, and leads many people to say that the heterodyne wavemeter is useless with such receivers. The average buzzer wavemeter, on the other hand, is also decidedly troublesome with such sets, which are rather too sensitive to allow it to be used in the same room; the difficulty is to get the buzzer type of instrument far enough away from the set to get anything like sharp readings.

An Alternative Type

These difficulties may not be insuperable, but being myself one of those who prefer to find an easy way round, it occurred to me that a description of a very simply-made

one, moreover, which is especially valuable for short-wave work. It can be used with a great variety of types of receivers, although it is specially useful with superheterodynes.

How it Works

It is exceedingly simple, consisting actually of merely a coil tuned by a condenser, and if just a little care is taken in making it up and choosing the components, it is extremely constant in its calibration.

How it works is an exceedingly simple matter: if a separate tuned circuit is placed in the neighborhood of a short-wave set which is in the oscillating condition—that is to say, in the state in which it is normally operated for C.W. reception, it will be found that when the tuned circuit comes into resonance with the receiving set the latter will suddenly stop oscillating with a noticeable click, and will start again only when the local circuit is detuned. That is, as the wavemeter circuit passes through the point of resonance with the receiver, the latter will stop oscillating, giving one click, and then will start again, giving a second click. If the wavemeter is placed at a suitable distance from the set, these two clicks are

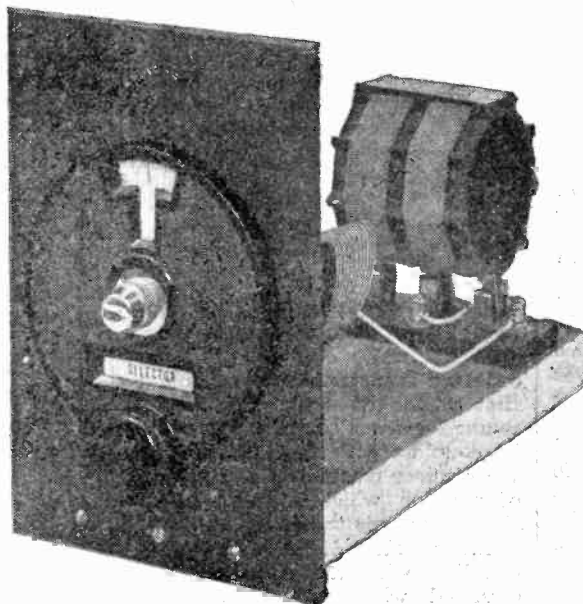

The wavemeter has interchangeable coils and a geared dial for the condenser.

wavemeter of a type which does not give these troubles might be acceptable.

In the absorption wavemeter we find an appliance of much usefulness in all such cases, and

sonance with the receiver, the latter will stop oscillating, giving one click, and then will start again, giving a second click. If the wavemeter is placed at a suitable distance from the set, these two clicks are

AN "ALL-WAVE" ABSORPTION WAVEMETER—(Continued)

almost coincident, and a very sharp indication is given, which renders the reading of the wavemeter a very simple matter.

The First Step

When deciding to build a wavemeter, the very first thing to do is to choose a really good variable condenser as nearly the most important component, and here the things to look for are a good and substantial method of construction, and really good and sound bearings, without the slightest sign of slackness or side-play.

The Vernier Dial

Having decided upon a good condenser, there comes the question of a dial, and if the instrument is to be used upon short waves, or with any very sharp tuning set, a slow-

ism is not in itself very serious, so long as it does not in any way affect the accuracy of the reading given by the graduated scale, this

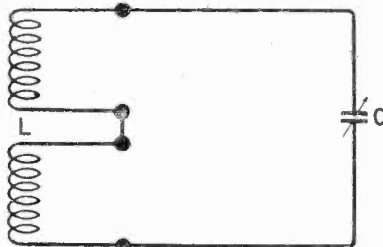

The circuit consists of a variable condenser shunted across a fixed inductance.

latter being a point to which great attention should be devoted. For this purpose, one of those kinds of dial in which the graduated scale

this part of the wavemeter oneself and it is obviously desirable that the inductance unit shall be readily interchangeable. The main requirements in the coil are that it shall be of reasonably low high-frequency resistance, of rigid and permanent construction, and shall be available in sizes to cover the wavelength range desired.

Construction

The constructional work involved in making up one of these wavemeters in its simplest form, assuming that the components themselves are not to be made, is only a matter of half an hour or so, and the one I am illustrating comprises simply a wooden baseboard, a vertical ebonite panel on which the condenser is mounted, and a base for the coil placed upon the wooden platform.

Materials

The materials required to produce an instrument like the one illustrated are as follows:—

One ebonite panel, 5 in. by 7 in. by $\frac{1}{4}$ in.

One wooden baseboard, 4 in. by 9 in. by $\frac{3}{8}$ in.

One base for "Dimic" coils and the necessary coils (L. McMichael, Ltd.).

One Igranite variable condenser, .0005 (Igranite Electric Co., Ltd.).

One Silver-Marshall slow motion dial (Rothermel Radio Corporation, Ltd.).

It will further be seen that I specify a baseboard $\frac{3}{8}$ inch in thickness, although the photo shows that the original is nearly an inch thick: the latter was the only thickness I had in hand when the meter was made, but the lesser thickness would have been more convenient.

Connections

No wiring diagram is given, since the wiring is such a simple matter that a verbal description is amply sufficient. Simply connect one end of the Dimic coil mount to one terminal of the variable condenser, and the other to the second terminal of the variable condenser. Join to each other the two terminals in the middle of the coil mount and the work is finished.

Similarly, no drilling diagram for the panel is necessary, since there is only one component to mount upon it, and this is placed at the centre

(Concluded overleaf)

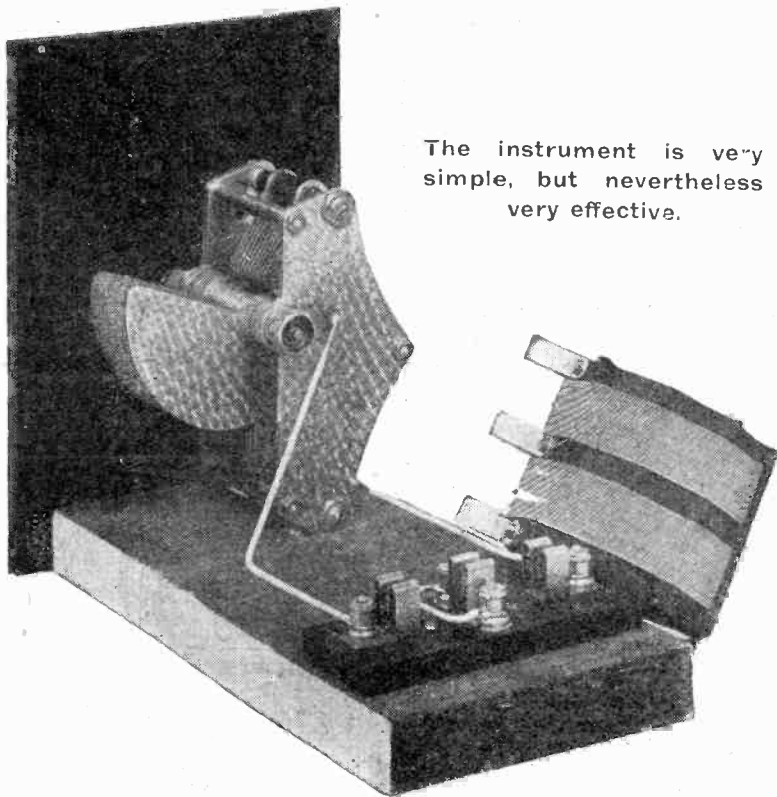

The instrument is very simple, but nevertheless very effective.

motion drive is practically essential. Here, again, some pains should be taken in choosing the component, and the slightest sign of backlash in the actual dial reading should be a sufficient ground for the rejection of that particular component. Backlash in the actual driving mechanism

or indicating dial is rigidly clamped to the spindle of the condenser is to be preferred.

Choosing a Coil

The choice of a coil is a very simple matter, since I am assuming that it is not desired to make up



Designed for strength

AT last there is a Coil which is not only electrically perfect, but is also mechanically strong—most coils are flimsy in construction, and after a little use become shapeless. The Eureka Low Loss Coil is so made that the greatest strength is in the base which bears the most strain. The ebonite rib, situated immediately above the plug, allows repeated removal from the socket without any damage whatever to the coil. The solid ebonite former and band also add materially to the strength of this fine coil.

Q Low Self Capacity

There is no coil on the market which has such a low self capacity—an examination will convince you of this. The unique method of winding, and the exact spacing of the high grade silk-covered wire permit of such a minute self-capacity that sharper tuning and therefore greater selectivity must result.

Q Handsome Appearance

Mechanical strength and electrical perfection are indeed sufficient to commend the Eureka Coil, yet, there is another point in its superiority—appearance. When you see this Coil at your Dealer's you'll at once agree that it is the most handsome coil you ever saw. Its green silk wire and neat finish will enhance the appearance of any Receiver. Glance at the prices alongside and see how little you have to pay for this super Coil.

Here is the range:

E20	40-150 metres	4/3
E25	55-250 metres	4/3
E35	80-375 metres	4/3
E50	120-560 metres	4/6
E75	185-760 metres	4/10
E100	285-1000 metres	6/3
E150	360-1500 metres	7/-
E200	470-1375 metres	8/-
E250	530-2725 metres	8/6

All the above wave-lengths are obtained with a 0005 mfd. variable condenser in parallel.

Portable Utilities Co., Ltd.
(Eureka Radio Products)
Fisher St., London, W.C.1

EUREKA

Low Loss Coils

AN "ALL WAVE" ABSORPTION WAVEMETER

(Concluded from page 269.)

of the panel, that is to say, the spindle of the condenser passes through a hole drilled in the centre.

Calibration

The calibration of the instrument can, of course, be undertaken in the usual way, by making use of the Radio Press calibration scheme, listening in to various distant stations upon one of the nights when their frequencies and wavelengths are being measured at our Laboratories at Elstree, subsequently making out the usual calibration chart, plotting frequency or wavelength vertically, and dial reading upon the wavemeter horizontally. Using a good coil and condenser an approximately straight line will result.

Using the Meter

In using the instrument with a superheterodyne receiver the procedure is first to tune in the station whose wave it is desired to measure, and then to place the wavemeter close to the windings of the frame aerial.

Now revolve the wavemeter condenser, and you will presently come to a reading which causes the signals to fade away and perhaps vanish. On either side of this reading they reappear, and it is quite easy to determine the exact spot which indicates their wavelength if the meter is placed at a suitable distance from the frame.

On Short Waves

A similar indication can usually be obtained quite easily by placing the meter fairly near one of the coils in any sharply-tuned receiver, but the main other use of this instrument is on short waves. A suitable "Dimic" should be inserted, and it will be found that a very clear indication of resonance between the meter circuit and the receiver is given, because the latter will stop oscillating as the meter is tuned through the correct setting and starts again as it passes beyond.

Two clicks are therefore heard, and when the meter is placed far enough from the set they almost merge into one.

ARE WE ON THE WRONG TRACK?

By A. W. MEREDITH

Who asks whether the values commonly used in a resistance-capacity amplifier are those best suited to the purpose in the light of recent developments.



FOR a long time resistance coupling has been employed for low-frequency amplification in cases where considerable purity of reproduction is desired. Provided that certain specified conditions are fulfilled, then the amplification

of a two- or three-stage note-magnifier can be made practically uniform over a wide range of frequency.

The Lower Registers

Resistance coupling has particular advantages at the lower end of the frequency range. It is difficult to construct a transformer which, with its valve, will give a uniform amplification at frequencies as low as one hundred cycles per second or less. Rapid strides have been made in this direction comparatively recently, but it is not so long ago that transformer amplification curves terminated at about 500 cycles per second, and the instrument was assumed good if all frequencies above this limit were amplified reasonably uniformly. The fallacy of this argument is seen at once when it is realised that middle C, that is to say a note about the middle of the actual audible range, is only 256 vibrations per second!

It is this desire, then, for uniform amplification practically irrespective of frequency that has led to the development of resistance-capacity coupling. If a resistance can be constructed to be free both of inductance and distributed capacity effect, then its impedance is purely resistive and is independent of the frequency.

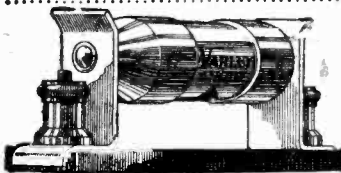

The value of the anode resistance largely depends upon the amplification ratio of the valve.

Suitable Values

The next thing to consider, therefore, is the actual value of the resistance to be employed, and this is determined to a very large extent by the valves in use. The amplification obtained from any given valve depends upon, first, the amplification ratio of the valve itself, and, secondly, upon the relation between the impedance of the valve and the external impedance in the anode circuit

(in this case a simple resistance). For efficient results it is essential that the external impedance shall be high compared with that of the valve, and this has led to the use of valves having an impedance of about 30,000 ohms with an amplification ratio of 20 used with a resistance in the anode circuit of 60,000 to 100,000 ohms.

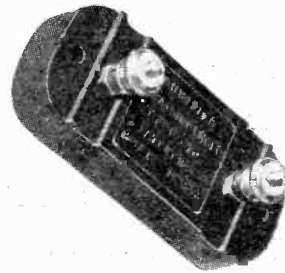

The value of the coupling condenser is determined partly by theory and partly by experiment.

H.T. Problems

Obviously the actual voltage applied across the valve itself depends upon the value of the external resistance. There is a certain voltage drop on the anode resistance due to the passage of the steady anode current, and this means that some compromise has to be effected between the high-tension voltage employed and the actual value of the resistance. All these points have been discussed many times before, and they need not be dealt with further at this stage.

Coupling Condensers

Having developed the voltage across the resistance in the anode circuit, however, it is then necessary to transfer this voltage to the grid of the next valve. Unless a separate battery is used on each valve, a method which is cumbersome and unwieldy, it is necessary to effect this transfer of energy by means of a suitable fixed condenser. A direct connection is, of course, not possible, as otherwise the high-tension voltage would be applied to the grid of the succeeding valve, and this would paralyse it and prevent any amplification at all.

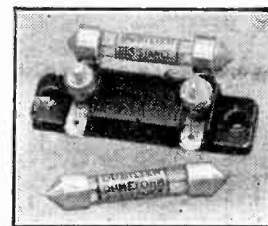

The grid resistance requires careful consideration in designing a resistance amplifier.

Actual Impedances

The value of this coupling condenser has been determined partly by theory and partly by experiment. Actually a value of something like 0.1 is utilised. Let us consider what the effect of such a condenser would be upon the actual circuit in question. The impedance of a condenser depends upon the frequency of the current flowing

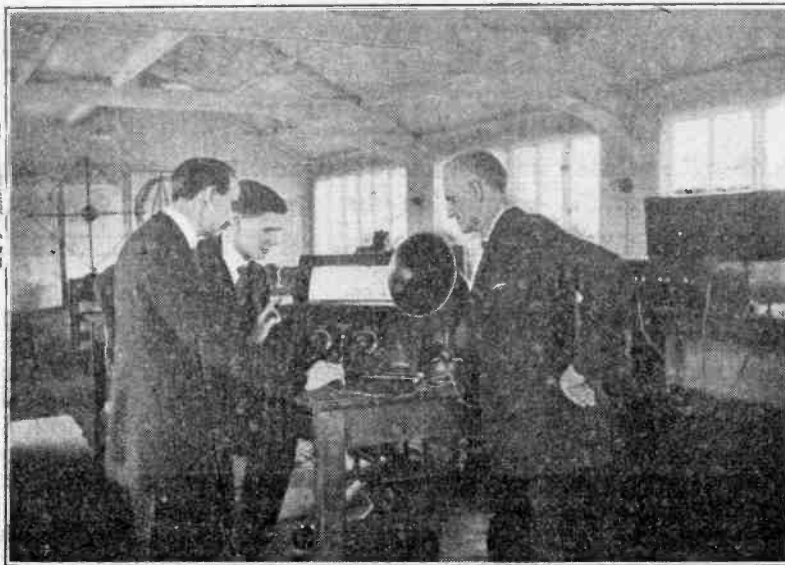

Showing the presentation of the first prize in Competition No. 6.

**“Cartoonigraf” Competition No. 8
appears in Aug. 7 issue of WIRELESS**

BY entering into the “Cartoonigraf” Competitions any reader of WIRELESS may be the fortunate winner of one of the many handsome prizes.

To give you an example of their value, the first three successful entrants in Competition No. 7 were presented with

The Curtis “Double Circuit Super-Het Eight” complete with valves.

One 60 volt H.T. Accumulator by A.F.A. Accumulators Ltd.

Three Voltron Valves.

50 Consolation Prizes consisting of Radio Press Handbooks were awarded to commendable entries.

Buy your copy of “Wireless”—the weekly journal which provides a new outlook for every home constructor—containing full particulars and entry form for the “Cartoonigraf” Competitions, only one of its many attractive and interesting features.

2^D. WIRELESS *(Incorporating
Wireless Weekly)*

WEEKLY

*Obtainable from all Newsagents, Booksellers,
Bookstalls, or direct from the Publishers.
Subscription Rates 13/- per annum (13/- per
annum Canada and Newfoundland). Lesser
periods pro rata.*

**Buy your copy next Tuesday
and enter Competition No. 8.**

RADIO PRESS LTD.
Bush House, Strand, London, W.C.2.

ARE WE ON THE WRONG TRACK? — (Concluded)

through it. In the particular case just quoted, that of a .01 condenser, the impedance at a frequency of 100 cycles per second would be about 160,000 ohms, and the impedance at a frequency of 1,000 cycles per second would be about 16,000 ohms.

Variation with Frequencies

The significance of this may be easily appreciated. At a frequency of 1,000 the impedance of the coupling condenser is only a small fraction of the actual anode resistance and it becomes increasingly smaller as the frequency rises.

Down towards the lower end of the scale, however, where we are more particularly concerned, the impedance of the coupling condenser rises rapidly, and at 100 cycles is greater than the value of the anode resistance itself. Obviously, therefore, the transfer of energy through this coupling condenser will vary with the frequency, the amount of energy transferred being less at low-frequency than at high.

A Serious Defect

This is the very effect which resistance coupling is employed to overcome. In order to overcome this defect, we have two alternatives. One is to make the condenser very large so that its impedance is always negligible in comparison with the value of the resistance in the anode circuit. This has the disadvantage of being more expensive.

The other alternative is to reduce the size of condenser so that the impedance of the coupling condenser is always fairly high. At the same time, if this is done, it is desirable to increase the actual value of the resistance in the anode circuit. This at once brings in its wake the difficulties of high-tension supply, since the voltage drop on the anode

resistance will then be so heavy that the voltage actually applied across the valve is quite small.

Recent Developments.

The latter aspect of the question has, in the past, prevented this method of resistance coupling from being used to any great extent. Recently, however, certain experimenters have tried the effect of designing resistance-coupled amplifiers on this principle. Values of resistance of 500,000 ohms have satisfactorily been employed in the anode circuit with a coupling condenser as small as .001. In fact, the anode resistance has been increased to a value of several megohms with, if anything, slightly improved results.

The Grid Leak

At the same time the grid leak requires a certain consideration. It is essential to stabilise the grid of the succeeding valve in some manner, as it is normally isolated by the coupling condenser. With the more usual form of resistance coupling this leak is made comparatively small, having a value of the order of one-quarter to one-half a megohm. Such small values would be quite unsuitable with a very high anode resistance, as this would result in a low-resistance shunt being placed across the anode resistance itself, which would destroy the good effect of the high resistance. The grid leak, therefore, must be kept at a fairly high value, and in some cases may even be omitted altogether without any deleterious effects.

Modern Valves

As previously mentioned, the actual voltage on the valve itself is extremely small with such an arrangement, but the modern valve is such that it still retains a characteristic of appreciably good quality, even at small anode voltages, so that satisfactory amplification can be obtained.

THE WIRELESS TRADE AT ELSTREE



Our photograph shows a member of the Wireless Industry operating the "Elstree Six."

Among the members of the wireless industry who have seen and heard the "Elstree Six" working the following representative names indicate the great trade interest created by this now famous receiver.

Beard and Fitch.
 Sydney S. Bird.
 Bowyer-Lowe Co., Ltd.
 Burne-Jones & Co., Ltd.
 Darimont Batteries, Ltd.
 General Electric Co., Ltd.
 Igranic Electric Co., Ltd.
 London Electric Wire Co., Ltd.
 I. McMichael, Ltd.
 Mullard Wireless Service Co., Ltd.
 Radio Instruments, Ltd.
 A. J. Stevens Co. (1914), Ltd.
 Claude Lyons.
 Electron Valve Co., Ltd.
 Formo Co., Ltd.
 Collinson's Precision Screw Co., Ltd.
 Peto Scott Co., Ltd.

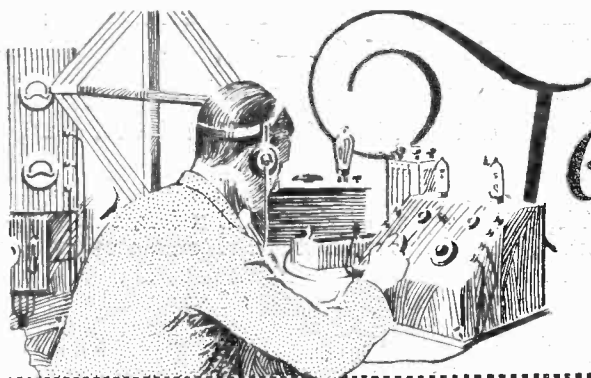

Tested by Ourselves

Filament Fuse

A DEVICE submitted by Messrs. Phillips is a small fuse for connection in the H.T. circuit where it limits the current to about 30 milliamps. It consists of a thin wire sealed into a small glass tube, with two terminals at the end. Under normal working conditions the drop of the H.T. voltage is very small. If the filament of one valve (or several valves) is accidentally caused to make connection with an H.T. battery, the momentary increase of current causes the wire to fuse before any damage is done to the filament.

We have tested this filament fuse and find that it carries out the claims of the manufacturer. We

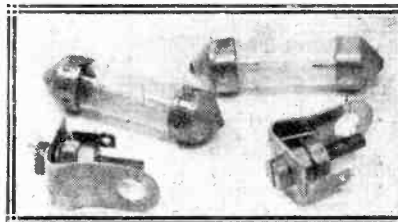

Phillips filament fuses and their clips.

can recommend it, therefore, to all our readers.

General Radio Low-loss Coil

WE have received from Messrs. Claude Lyons, the agents for the General Radio Co. of America, a range of low-loss coils. These coils are wound on a 2 1/2 in. diameter Bakelite former, and are wound in two equal sections, the ends being brought out to four screw terminal plates. A bar across the bottom of the moulding contains four holes, into which pins may be inserted and held by a small nut, and connections are made from these

pins to the winding. The four pins fit into a special holder containing four sockets provided with soldering tags.

Since the coils are wound in two

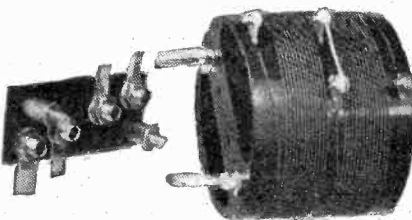

A divided low-loss coil submitted by Messrs. Claude Lyons.

equal sections, which may be connected together in the middle by a short strap if so desired, the coils are particularly suitable for the various split coil circuits which have been used to a considerable extent recently. The coils are of reasonably low-loss construction, and gave very satisfactory results when used in a receiver.

Etherplus Anti-vibro Valve Holder

THIS valve holder, which is constructed on low-loss principles, is designed for base-board mounting. The insulating material is placed some distance away from the valve sockets,

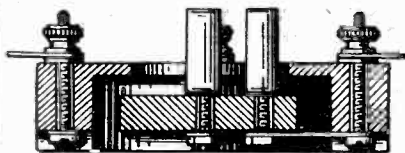

The Etherplus Anti-vibro valve holder.

the sockets themselves being mounted through a rubber base, which is claimed by the manufacturers to be non-deteriorating. Con-

nections from the sockets to the terminals are made by means of springy strips of metal, this springy action assisting in obtaining the necessary amount of anti-vibratory movement. Soldering tags and terminals are provided.

The component was tested in a receiver and was found to function quite satisfactorily, and damp out microphonic noises to a large extent. When a valve was inserted, it proved a good fit. The manufacturer of this holder is Mandaw, and we can recommend it as a well-designed and mechanically sound component.

Grid Leak

A GRID leak has been forwarded to our laboratories by the Igranic Electric Co. for examination and report. This

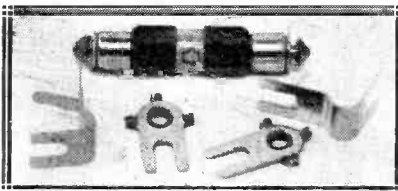

The Igranic grid leak has special mounting clips.

leak, which is of the fixed type, is particularly robust in construction, the resistance of the leak being plainly marked. Conical ends are provided, the leak itself being 2 in. in length, whilst an ingenious spring device under the conical ends allows a special clip to be employed for mounting it.

Two types of clips are provided with the component, one being for panel mounting and the other for soldering the leak in any position. The rated value was marked 2 megohms, and when placed on test it was found to be 2.3 megohms. This component is certainly a novel and ingenious piece of apparatus, and can be recommended with confidence.

"All Europe on a Frame"

Here are the component parts for this wonderfully efficient 8-valve Super-Heterodyne Circuit.

See "Modern Wireless" Current Issue, by Mr. Percy W. Harris, M.I.R.E.

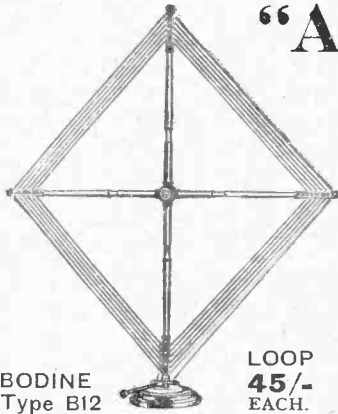

BODINE Type B12

LOOP 45/- EACH.

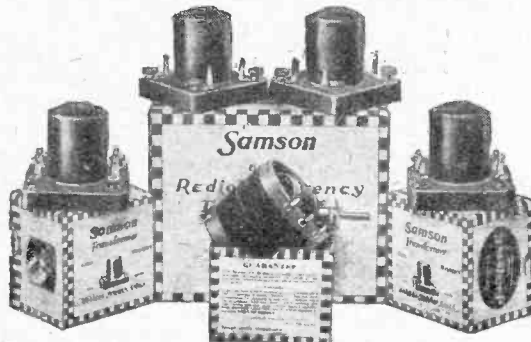

SAMSON SUPER-HETERODYNE KIT.
Consisting of 3 Samson Helical Wound Intermediate Frequency Transformers and one Samson Special Filter Transformer. Kit complete £6 0 0

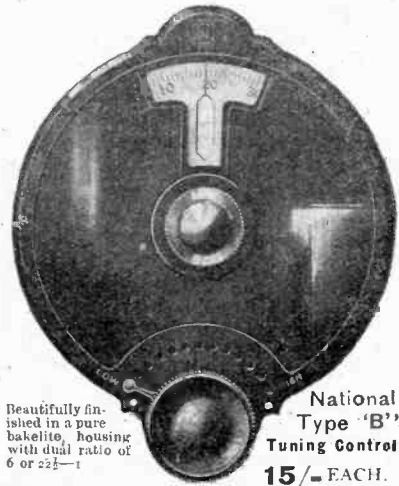

National Type "B" Tuning Control 15/- EACH.

Beautifully finished in a pure bakelite housing with dual ratio of 6 or 22-1

THE

ROTHERMEL RADIO CORPORATION OF GT. BRITAIN, LTD.

24-26, Maddox Street, Regent Street, London, W. 1.

Phone: Mayfair 578 & 579.

Grams: Rothermel, Wesdo, London.

Write for our 1926 catalogue of high class American Radio Apparatus and circuit supplement enclosing 9d. in stamps to cover cost of postage.

Obtainable from all high-class Radio Dealers. See page 280



SILVER MARSHALL SPACE WOUND OSCILLATOR COILS

ea.
No. 111a. 190—650m. 13/6
No. 111b. 90—310m. 13/6
No. 111c. 60—250m. 13/6
No. 111d. 65c—2000m. 16/6 (with 0005 condenser).

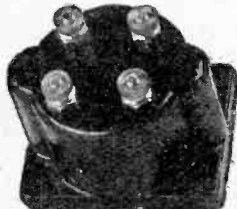

SILVER MARSHALL TRANSFORMERS.

Special kits consisting of 3 type 210 Intermediate Frequency Transformers and one type 211 filter with matched tuning condenser. £8 5 0

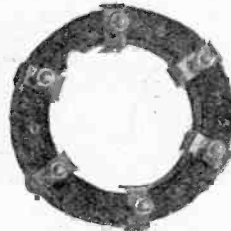

SILVER MARSHALL SIX POINT COIL SOCKETS. 5/6 each.

On Guard!

There is no leakage with a "Lotus" Buoyancy Valve Holder on guard. Immediate and lasting connection made when valve pins enter valve sockets. The leg socket expands and automatically locks.

Absorbs shock, protects the valves and eliminates all microphonic noises.



Made from best bakelite moulding with springs of nickel silver and phosphor bronze valve sockets.

Garnett, Whiteley & Co., Ltd.

Lotus Works, Broadgreen Rd., Liverpool. Makers of the famous "Lotus" Vernier Coil Holder.

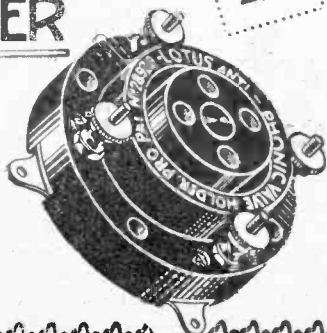

WITHOUT TERMINALS 2/3

WITH TERMINALS 2/6



A good Set deserves a good Panel

MOUNTING your components on an inferior panel is akin to 'spoiling the ship for a ha'porth o' tar.' It does not pay. When you buy a Radion Panel you are following the lead of the world's technical experts and are obtaining a positive insurance against surface leak-

age. Its superb mirror-like sheen enhances the appearance of the set, while actively repelling both dirt and moisture. Ask your dealer to show you a Radion Panel. You'll then fully appreciate its superiority — which mere words cannot describe.

RADION

Radion is available in 21 different sizes in black and mahogany. Radion can also be supplied in any special size. Black 1d. per square inch, mahogany 1 1/2d. per square inch.

American Hard Rubber Company (Britain) Ltd.

Head Office: 13a Fore Street, London, E.C.2.

Depots: 120, Wellington Street, Glasgow. 116, Snow Hill, Birmingham. Irish Agents: 8, Corporation Street, Belfast

G.A. 5485

Tell the Advertiser you saw it in "MODERN WIRELESS."

Reception to Perfection



Perfect reception can only be certain if you have a Coil Holder in which the moving block cannot fall back.

No other Coil Holder combines this quality with so many other essential features as the PENTON Type "A."

Eckleish Vanished Fading Banished.

Penton TYPE "A" GEARED COIL HOLDER Patent No. 19315.

The Only Perfect Coil Holder.

6/- of all good Radio Dealers, or post free direct from the manufacturers:—
THE PENTON ENGINEERING CO.,
15, Cromer St., Gray's Inn Rd., London, W.C.1.

WIRELESS BUREAU.
For your Wireless Set. Contact as a gramophone. High Grade Solid Oak, 3 Gns. to 6 Gns. Sent on approval. Write for Lists.

PICKETT'S CABINET WORKS.
(Members B.B.C.) (M.W.)
BEXLEY HEATH, KENT.



Valves Repaired
AS GOOD AS NEW!!

Except Weeco, S.P.'s and low capacity (3, es.) Minimum D.E. Current 4-15 strips when repaired.

At. Arg. et and Dali Emitters. L steel at less than 10/.

Minimum charge 5/-

VALCO LTD. Dep't. M. W. Tabor
Gröve Wimbedon, SW

HALF LIST PRICE

REPAIRS

By specialists skilled in every form of accurate and intricate coil winding

Headphones, Loud Speakers and Transformers rewound, remagnetised, and reconditioned

EQUAL TO NEW
and returned the same day on C.O.D. system. The unsolicited opinion of one of our many satisfied clients: "—all I can say is, they are better than when new."

VARLEY Magnet Co.
Renewal Dep.
Woolwich, E. 19

VARLEY Proprietors
Clive Hill
Croydon, S.W.

LITTLE WIRELESS CO. LTD.

MAP

Small Parts to the Trade.

MAP Co., 246 Gt. Lister St., Birmingham.



A WIRELESS DOCTOR
If your set is giving trouble or you want advice, a competent expert will call and put you right (London and Home Counties). No result, no charge. Sets installed and maintained.

ALEXANDER BLACK,
2a Woodville Grove, N.16. Clissold, 3687.

TESTED BY OURSELVES—(Contd.)

Vernier Rheostat

SUBMITTED by Messrs. King Quality Products, Ltd., a King Quality vernier rheostat has been tested at our laboratories. The ordinary 6.5 ohm resistance element is wound on a fibre strip, while the vernier winding is a single turn. The vernier spindle passes through the hollow main spindle, and it was found that the total variation obtainable with the vernier was .15 ohm. The rheostat was found to be exceptionally noiseless in use and to carry .8 amperes without undue heating.

Junior "Ideal" L.F. Transformer

THE Junior model "Ideal" transformer manufactured by Messrs. the Marconi-Phone Co., Ltd., has been tested at our laboratories. This instrument was found to produce a high degree of amplification, whilst the quality of reproduction was in every way satisfactory. The transformer can be thoroughly recommended as a general-purpose instrument.

Toggle Switch

OUR Elstree Laboratories have examined one of the bakelite toggle switches forwarded by Messrs. The Rothemel Radio Corporation of Great Britain.

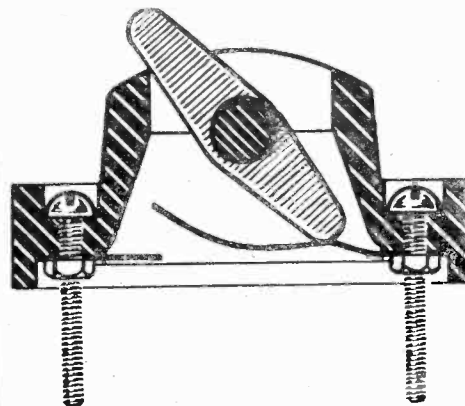

A diagram showing the construction of the Toggle switch.

This switch is exceedingly neat and compact, consisting of a circular moulding of insulating material 1 1/4 in. in diameter. In the centre of this is a small cylindrical projection

with a dome top to it which has a slot cut down its centre, and in this slot a small black insulated lever moves. The switch is plainly marked for on and off positions, and the two small screws for fixing also make electrical contact with the two parts of the switch. The mechanism is neat and simple, and

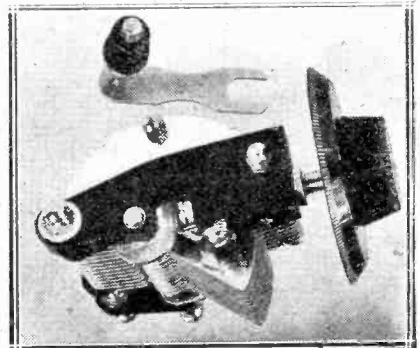

The Devicon true scale friction condenser.

provides a quick break and a positive contact.

The actual resistance of the component was measured and found to be negligible, and when in the off position the insulation resistance was infinity. Over two amperes were passed through the switch, and it did not show any signs of heating. We can recommend this component for use.

Ormond L.F. Transformer

ONE of the L.F. transformers made by Messrs. the Ormond Engineering Co., Ltd., has been tested at our laboratories with good results. It is of the non-shrouded type, and gave good quality reproduction. Considering the low price, its performance may be considered very satisfactory indeed.

Devicon True Scale Friction Condenser

MESSRS. THE RADIO DEVICES CO., who specialise in the manufacture of condensers,

have sent to our Laboratories one of their true scale friction condensers for examination.

The component is fitted with a neat ebonite knob and dial, the

The Choice of Experts!



GOOD ADVICE

LONG-WAVE TRANSFORMERS for use in Supersonic Heterodyne Receivers must be highly efficient or your efforts are doomed to certain failure.

"G.R." Transformers are the only shielded, Laboratory "Matched" Transformers. They were the first and are still by far the best. Use them for the Superhet. described in this issue, and be certain of good results.

Complete Kit of 4 Instruments in original carton, sealed at the works, fully guaranteed (money back if not satisfied), only £4 10s.

Complete Constructional Blue Prints of our own Superhet. Circuit (Panel and Baseboard Layout, Circuit, Specification and Actual Wiring Diagram) 2s. 6d. post free (refunded with an order for Transformers).

Complete Art Catalogue (36 pages) of 118 "G.R." Radio Components for the Enthusiast, SIXPENCE post free (refunded with first order). 60 Illustrations, numerous Circuits, exclusive Information re Coils, Transformers, Condenser Design, etc. An essential to all keen Amateurs. Includes all details of the Internationally Famous "G.R." "Universal Four" Receiver.

All "G.R." Components on show at Hamley's, 200, Regent Street, W.1.

From any good dealer or (post free)

CLAUDE LYONS
76, Old Hall Street, Liverpool

Tel.: 4641 Central. 'Grams: "Minmetkem," L'pool.

Why not?

purchase your units for the "ELSTREE SIX" a few at a time and each week obtain some necessary component part? This set is so good that you will be wanting to make it up for yourself as soon as the darker evenings are with us. Below we give a priced list of the necessary units as suggested:—

- 4 Cylidon .0005 dual condensers at 27/6 each ... 110/-
- 1 Neutralising condenser, Igranic, panel mounting ... 5/6
- 2 Double circuit jacks at 2/6 each ... 5/-
- 1 Potentiometer, Lissen ... 4/6
- 1 Filament key switch, Igranic ... 3/-
- 1 Marconi Ideal transformer 2.7-1 ... 30/-
- 1 Marconi Ideal transformer 6-1 ... 30/-
- 1 H.F. choke, Lissen ... 10/-
- 100,000 ohm anode resistances, with base, Mullard, at 5/6 each ... 22/-
- 1 Grid battery, 9-volt Hellesen ... 2/3
- 1 Pair grid battery clips ... 1/6
- 6 Valve holders, Benjamin, at 2/9 each ... 16/6
- 4 Dimic bases, McMichael, at 2/6 each ... 10/-
- 4 Single-coil mounts, Burne-Jones, at 1/9 each ... 7/-
- 3 Neutralising condensers, baseboard mounting, McMichael, at 4/9 each ... 14/9
- 6 Amperites, No. 1a, 6 volts 25 amps., at 6/- each ... 36/-
- 1 Terminal strip containing 8 engraved ebonite terminals ... 7/6
- 1 Terminal strip containing 2 engraved ebonite terminals ... 2/-
- 4 Decko dial indicators at 9d. per pair ... 1/6
- 6 .002 Dubilier condensers at 3/- each ... 18/-
- 1 Wooden panel, 42in. by 9in. high ... 10/6
- Or alternatively one ebonite panel ... 16/-
- 1 Wooden baseboard, 42in. long by 13 1/2in. in depth, with side brackets for supporting panel ... 8/6
- 1 Wooden board, 42in. by 24in. wide ... 8/6
- 1 Oak or mahogany cabinet, American pattern, 42in. long by 9in. by 13 1/2in. ... 8/6

Valves recommended are 4 Marconi D.E.5B and 2 D.E.5 or Mullard D.F.A.4 and 2 D.F.A.1. All at 22/6 each.

Coils recommended (wavelength 150-450 metres): 4 No. 1 Dimic; 4 Burndepth "C" coils (wavelength 250-600); 4 No. 1A Dimic; 4 No. 50 Lissen or Igranic (1200-3000); 4 No. 3A Dimic; 4 No. 3000 Lissen or Igranic.

MARCONI LICENCE ... 12/6 per valve

Send 6d. ONLY to cover cost of postage and packing of the finest INTERNATIONAL RADIO CATALOGUE ever issued. A storehouse of information and a veritable guide-book to the industry.

WILL DAY, LTD.,

19, Lisle Street, Leicester Square, London, W.C.2

TELEPHONE: Regent 4577.
TELEGRAMS: Titles, Westrand, London.



Use THE **CLARTONE** Britain's Best

FROM ALL RADIO DEALERS

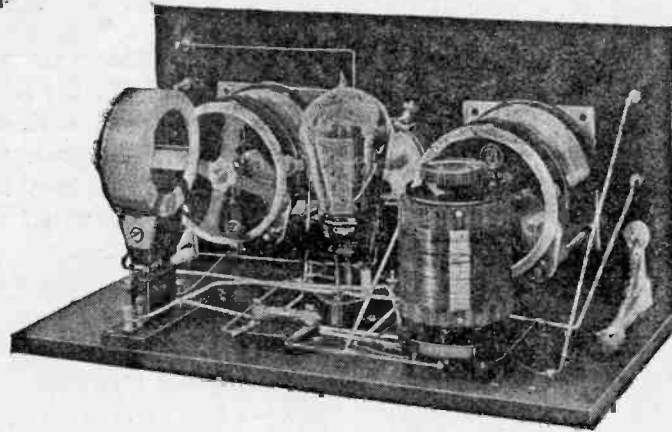

The Circuit is changed by changing the Coil

By the use of special coils Mr. S. G. RATTEE describes how it is possible to employ the attractive properties of the Reinartz circuit on the ordinary broadcast waveband, and to change over to a direct-coupled aerial employing magnetic reaction on the longer waves. No switches or jacks are involved—the change-over of connections being automatically brought about by the design of the plug-in-coil units.

The wavelength range of this receiver is such that by simply changing the coil, signals may be received on the relatively short waves, over the broadcast band, up to the longer wavelength stations of Daventry and Radio Paris.

Besides his popular feature "Talks to Beginners" Mr. Harris describes under the heading "Australia on Two Valves" a short-wave Receiver, the results from which, by carefully observing the author's instructions, may be duplicated even by the beginner in short-wave work.

If you follow the design of The "Davlow Three" also published in the August issue of THE WIRELESS CONSTRUCTOR, you will build a receiver which, on points of simplicity of operation, quality and general reliability will give you every pleasure.

BUY YOUR COPY TO-DAY

The Wireless Constructor

AUGUST ISSUE
NOW ON SALE

From all Newsagents, Bookstalls and Booksellers, or direct from the Publishers, Radio Press, Ltd., Bush House, Strand, London, W.C.2. Subscription Rates, 8/6 per annum United Kingdom, 7/6 per annum Canada and Newfoundland, and Other Countries 8/6 per annum. *Lesser periods pro rata.*

Contents include:

- The "Davlow Three." By W. Q. Kay.
- Making the Best Use of Your Environment. By A. V. D. Hart, B.A.
- Australia on Two Valves. By Percy W. Harris, M.I.R.E.
- In Scandinavia with a Super-Hot. By Capt. L. F. Plugge.
- Change Your Coil and Change Your Circuit. By Stanley G. Rattee, M.I.R.E.
- Do You Keep a Crystal Check? Talks to Beginners. By Percy W. Harris, M.I.R.E.
- Try These New Selective Circuits. By W. S. Percival, B.Sc.(Hons.), A.R.C.S.

Contents include:

- Was the Designer Wrong? By John Fugh-Price.
- Have You Made Your Portable Set? By D. J. S. Hart, B.Sc.
- A Home-Made Vernier Condenser. By P. H. Wood, B.Sc., F.P.S.L.
- Workshop Hints for the Home Constructor. An All-Purpose Valve Unit. By L. H. Thomas.
- Where Insulation Matters. By O. P. Allinson, A.M.I.R.E.
- Points to Watch in Coil Holders. By H. J. Barton-Chapple, Wh. Sch., B.Sc. (Hons.), A.C.G.I., B.I.O., A.M.I.R.E.
- How to Wind Spaced Single-Layer Coils. By W. H. Fuller.

**TESTED BY
OURSELVES**
(Continued)

condenser being driven through a 2 to 1 gear, while a vernier attachment provides an additional slow motion. No end plate is employed at the top of the condenser, a supporting shoulder piece being utilised instead, thus making the instrument considerably stronger.

By means of the knob a friction disc is rotated, and this in turn rotates the friction wheel, a particularly fine even motion being obtained. There is an extra ebonite support for the two terminals, while one hole fixing is provided for.

The rated capacity of the condenser is .0005, but on test it

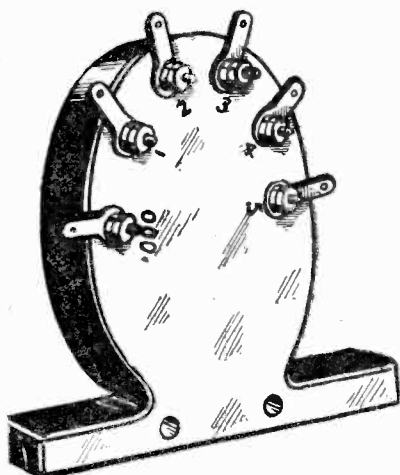

Fourteen different values are obtainable with this C.A.V. condenser.

registered a shade under this value.

The introduction of this instrument will certainly meet with the favour of our readers, and we can recommend it for use.

**C.A.V. Multiple Fixed
Condenser**

A CONDENSER unit capable of giving 14 different values of capacities according to the method of connection has been forwarded to us for examination by Messrs. C. A. Vandervell and Co., Ltd.

The unit is exceedingly neat in appearance, being circular in shape except for the fact that a base is provided so that the condenser may be screwed to a panel or baseboard

The "Magic Five"

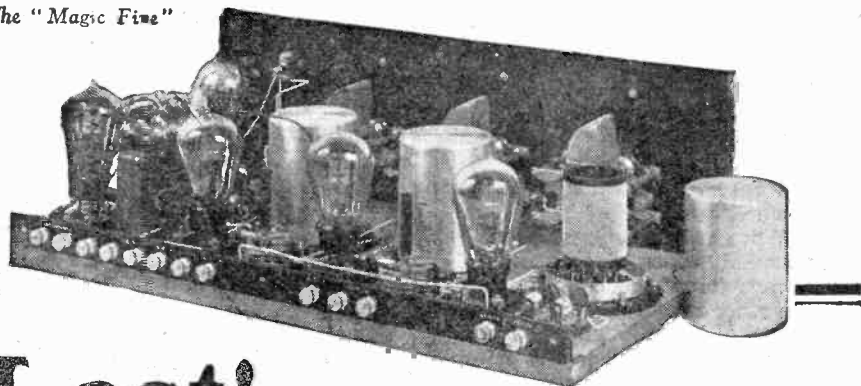

Lost!—your local station

A mile and a half from 2LO, and listening to Manchester without a trace of London! Such is the selectivity now realised in recent Radio Press sets—made possible by the use of Screened Coils.

Perhaps no problem has ever received so much attention in radio history as that of selectivity.

Numerous experts have been continually engaged in probing the many difficulties met, and, from time to time, claims have been made for effective solutions. These have always proved to have no value, but now the whole trend of set design has been revolutionised, and a new era opened up in broadcast reception.

Cōpex Coils definitely eliminate unwanted interaction.

Being fully shielded and earthed, the external magnetic field is neutralised, and there can be none of that interaction between coils which so often causes uncontrollable oscillation. With Cōpex Coils in the set much of that troublesome outside interference is unknown.

Cōpex Coils put a wonderfully fine edge on your tuning and the set is extremely stable, infinitely more selective and capable of superior tone with a complete absence of mush.

These new coils can be used in several of the latest Radio Press sets—including the "Five Fifteen" and the "Magic Five"—and are likely to be the basis of many improved circuits to come, and indeed, the whole trend of future wireless developments.

Cōpex Coils are copper screened.

The superiority of copper over aluminium as a screening metal has been recognised by experts. Don't spoil the ship for a ha'porth of tar—don't risk mediocre results by using an inferior set of coils. Choose Cōpex and be sure of the best results always.

Cōpex Coils

are interchangeable on a standard six pin base. Copper unit with base (patent applied for) 15/- Plug-in low loss coils from 4/6 upwards according to wavelength

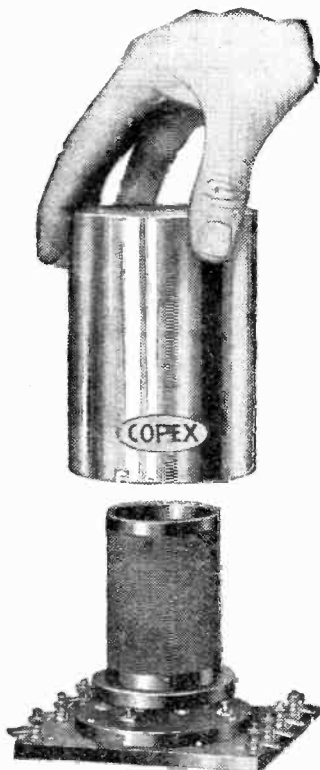

Pat. applied for

**PETO-SCOTT CO., Ltd.,
77, City Rd., London, E.C.1**

Branches—LONDON, 62, High Holborn.
W.C.1. WALTHAMSTOW, 230, Wood St.
PLYMOUTH, 4, Bank of England Place.
LIVERPOOL, 4 Manchester Street

Tell the Advertiser you saw it in "MODERN WIRELESS."

TESTED BY OURSELVES — (Continued)

either vertically or horizontally. The case containing the fixed condensers is manufactured from ebonite.

When using the component one terminal which is marked .000 always forms one connection, and the other connections may be taken to any of the points marked 1, 2, 3, 4 or 5, which will give a value of .0001, .0002, .0003, .0004 or .0005 respectively. If higher capacity values are required it is necessary to join the terminals, and take the connection from either of the two so joined—thus 5 and 1 joined together will give a value of .0006. The sum of the numerals indicates the value. Both nuts and soldering tags are provided.

When tested at our Laboratories the capacities were found to be .0001, .00015, .0002, .0004 and .0005.

We should have liked to see the .0002 and .0003 capacities nearer to the rated value, but apart from this the component can be recommended for use.

'M.H.' Resistance Coupler
THE resistance - capacity coupling unit made by Messrs. L. McMichael, Ltd., consists of an anode resist-



The auto audio-frequency amplifier made by Messrs. Bretwood, Ltd.

ance, coupling condenser and grid leak mounted on a special base. On test, the amplification was up to the standard for such an arrange-

ment, while the reproduction was very good, with a satisfactorily silent background.

Auto Audio-Frequency Amplifier

WE have received one of their auto audio-frequency amplifiers from Messrs. Bretwood, Ltd., for test and report. This instrument, we understand, is a special form of choke-coupled amplifier, uniform amplification being claimed at all frequencies, in addition to a special filtering effect which produces a very silent background when two or more stages are employed.

On test it was found that in a first stage L.F. amplifier the degree of amplification was well up to standard, the quality of speech and music being particularly good, while the background was noticeably silent. In the second stage results were above the average, the quality of both speech and music being excellent.

USEFUL INFORMATION

Our complete catalogues of High Class American Radio Apparatus contain a wealth of useful information on the latest American developments together with many interesting circuit diagrams. They will be mailed free and post free to any reader applying for Radio Lists (M.W.).

The following components, recently tested and used by experts on the staff of "MODERN WIRELESS," can be supplied from stock:—

- Remler Transformers, 35/- each.
- Silver Marshall Transformers, 41/9 each.
- Samson Super-Het. Kits, £6 6 0 each.
- Silver Marshall Coils from 13/6 each.
- Remler Twin Rotor Condensers, 31/9 each.
- Amperites, 5/- each.
- Jacks and Plugs from 2/- each.

Other specialities include:—
Short wave outfits, General Radio Co. (of America) apparatus, Frame aerials, Low-loss Condensers and Coils, Super-heterodyne kits, Geared dials.



200-202, REGENT ST., LONDON, W.1.

Telegrams: "Pleasingly, Piccy." Telephone: Regent 3160 (6 lines).

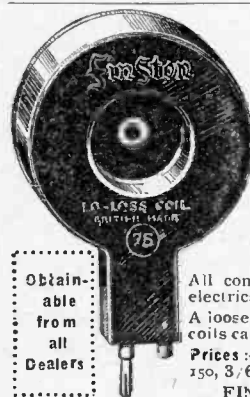

Finston SUPER COILS

Are totally enclosed in moulded Bakelite cases giving great mechanical strength, without impairing their efficiency. The coils have been so constructed that the centres are always in alignment when two or more are used, thereby securing maximum results from their magnetic field.

All connections are soldered, so as to give constant electrical continuity throughout. A loose plug is provided so that the winding of the coils can be reversed if so desired.

Prices:—25, 35, 40, 2/6 each; 50, 60, 3/- each; 75, 100, 150, 3/6 each; 175, 200, 4/- each; 250, 300, 4/6 each.

FINSTON MANUFACTURING CO., LTD., 45, HORSEFERRY ROAD, WESTMINSTER, LONDON, S.W.1.

PAIRS AD.

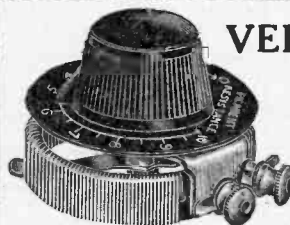

VELVET CONTACT

—the outstanding quality of the new Etherplus + V.C. Rheostat!

Neat, attractive pointer-knob fits flush to engraved dial, over one-hole fixing nut.

PRICE

6 ohms or 30 ohms } 2/3 each

From dealers or from

MANDAW 9-15, Whitecross St., London, E.C.1



REPORTS ON INTERESTING COMPONENTS

Indicating Tags

COLOURED indicating tags formed of some celluloid-like insulating material have been submitted by Messrs.

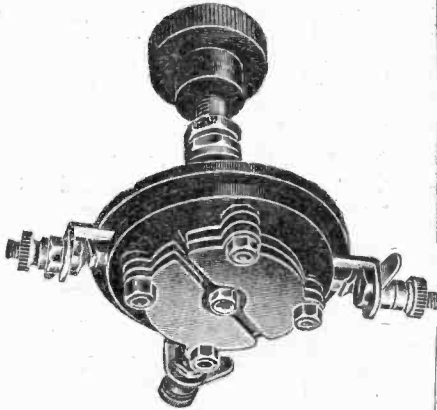

The Igranic balancing condenser.

F. E. Wilson & Co. They are lettered with the usual wording, and are intended for attachment to leads for identification purposes.

These indicating tags can be recommended as useful accessories.

Regenerative Aerial Tuner

MESSRS. Falk, Stadelmann & Co., Ltd., have forwarded an aerial regenerative tuner for test purposes. This component, cylindrical in shape, has a large and small knob for controlling respectively the inductance in circuit and the amount of reaction. The wavelength range covered was 300 to 2,000 metres when used in conjunction with a .0005 variable condenser joined in parallel. The reaction coil functioned satisfactorily on all wavelengths received.

This component can be recommended for use where it is not desired to employ plug-in coils.

Balancing Condenser

MESSRS. The Igranic Electric Co., Ltd., have sent us one of their vernier balancing condensers for test

and report. This component is intended for use where dual condensers are used to tune two separate circuits, in that it affords a method of compensating any inequality either in the two halves of

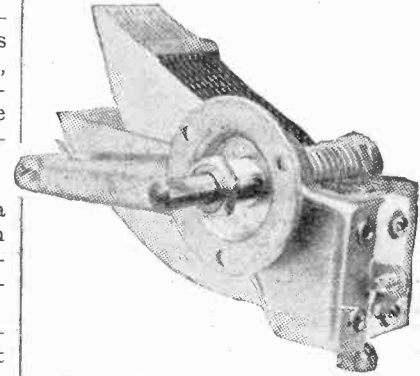

The straight-line frequency condenser sent in by Messrs. Igranic Electric Co., Ltd.

the dual condenser or in the two inductances that are being used. The component consists of two

—try the difference yourself

Choke amplification provides a real reason for rebuilding your present set. You will find—as many thousands of other experimenters have discovered—that it enjoys many distinct advantages over every other method of L.F. coupling. With the correct value leak and coupling condenser the quality of reproduction is strikingly rich, amply compensating for the slight decrease of signal strength secured by Transformer Coupling. Try the experiment yourself—you will be satisfied.



SUCCESS SUPER CHOKE, Price 18/6.

BEARD & FITCH, LTD.,
34, AYLESBURY ST.,
LONDON, E.C.1.
And at 1, Dean Street,
Piccadilly, Manchester.

FADA Radio



30 Stations in 15 Minutes

on
FADA 169a 5-Valve Complete Components
"TESTED AT ELSTREE."

FADA RADIO LTD.
31, Kingsway, W.C.

Send coupon for repair book "How to build a 5-Valve Neutrodyne" Free!

CUT THIS OUT FOR CABINETS

Send for FREE list illustrating Cabinets as shown in "Modern Wireless," etc. etc.

NAME
ADDRESS

(Write in block letters please)

CARRINGTON Mfg. Co., Ltd.
18-20, Normans Buildings, Central St., London, E.C.1.
Trade enquiries especially invited.



Tell the Advertiser you saw it in "MODERN WIRELESS."

MODERN WIRELESS MAGNUM SCREENED COILS

As developed by Mr. J. H. Reyner, and described in "Wireless Weekly."

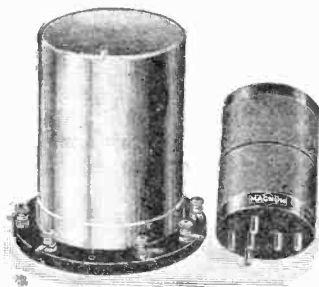

Screening box complete with 6-pin base, mounted on ebonite ...	£0 15 0
Aerial coil, 250/550 metres ...	0 4 6
H.F. Transformer for use with above ...	0 7 6
Complete set for Magic Five ...	£3 3 0
For Daventry Wavelength:	
Aerial coil ...	0 5 6
H.F. Transformer ...	0 10 0

THE "ELSTREE SIX"

Complete set of Components for this wonderful Receiver, as specified by the Author ...	£26 0 0
Set ready wired and tested ...	£29 0 0
Plus Marconi Royalties ...	£3 15 0

THE "MAGIC FIVE"

Complete set of Components as described in "Wireless," May 29 and June 5 ...	£13 4 0
Set ready wired and tested ...	£15 15 0
Plus Marconi Royalties ...	£3 2 6

CONSTRUCT THE QUALITY FIVE

as described in this issue by
Mr. John W. Barber

1 Radion Mahoganite Panel, 24 by 7 by 3/16, drilled ...	£0 19 0
1 Camco Cabinet, with drop front and baseboard ...	3 0 0
3 Eureka Variable Condensers, .0005 S.L.F. ...	2 6 6
3 Igranac Patent slow motion dials ...	1 5 6
1 Igranac Push-pull switch ...	0 2 6
2 Magnum Angle brackets ...	0 2 6
1 Grid bias battery, 9 volts, and 3 wander plugs ...	0 2 6
5 Lotus valve holders ...	0 11 3
1 Igranac Neutralising condenser (panel mounting) ...	0 5 6
5 Temprytes, No. 4, on mounts ...	1 0 0
4 Single coil mounts ...	0 7 0
3 Mullard 100,000 ohm resistances on bases ...	0 16 6
3 Dubilier fixed condenser, .01 mfd. ...	0 4 0
3 McMichael Grid Leaks on bases, .25 leak ...	0 10 6
1 Watmel, .0003 condenser, and 2 meg leak ...	0 2 6
1 Terminal Strip with 8 terminals ...	0 4 0
1 Terminal Strip with 2 terminals ...	0 1 0
Glazite ...	0 2 4
1 Set R.P. Transfers ...	0 0 6
	£12 3 7

LISTS ON APPLICATION.

BURNE-JONES & CO., LTD.,

Manufacturing Radio Engineers,

MAGNUM HOUSE,

296, Borough High St., London, S.E.1

Telephone: Hop 6257.
Telegrams: "Burjomag, Sedist, London."
Cables: "Burjomag, London."

AUGUST, 1926

Protect your Valves by using MAGNUM FIXED RESISTORS

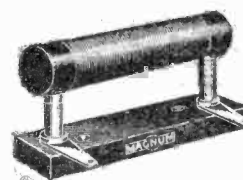

Supplied in ranges to suit all types of Valves.

When building your next set specify MAGNUM resistors. They eliminate unsightly knobs, ensure correct filament temperature, and prevent over-running.

Resistor on base, as illustrated ... £0 2 6
Resistor only (all valves) ... 0 1 9

NOTE.—Owing to the numerous types of valves operating on different voltages, it is advisable when ordering to state make and type of valve used, and voltage of accumulator.

Use Magnum Resistors for the ELSTREE SIX

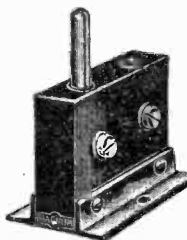

MAGNUM SINGLE COIL HOLDER

As used in the Elstree Six For baseboard mounting. Price 1/9.

Send stamp for latest Lists dealing with Radio Press constructional sets, and new illustrated catalogues

NOTE.—Where a complete set of Components, together with a drilled panel, is purchased, Royalties at the rate of 12/6 per valve holder, are payable.

EVERY



L. F. TRANSFORMER INCORPORATES THIS BY-PASS CONDENSER

Which is included in the price.

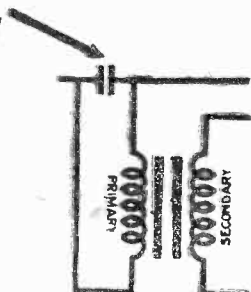
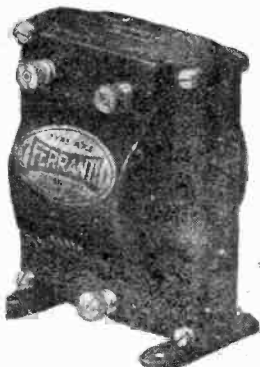

TYPE AF4 - 17/6

TYPE AF3 - 25/-

The "Nearly Perfect" Transformer.

Ask your Dealer for Leaflets Wa 401 and Wa 402
FERRANTI Ltd. Hollinwood, Lancashire.

Concentrated Efficiency

You don't really know the possibilities of your circuit until you adopt the "Polar" Coil Unit.

It increases efficiency—saves space—simplifies wiring—and actually costs far less than other methods of aerial tuning. There is a distinct increase in volume from distant Stations, a distinct improvement in selectivity and the micrometric adjustment enables the operator to get 50 per cent. more efficiency from his reaction without breaking into oscillations, and to obtain maximum volume without distortion. The compactness of the Coil-windings minimises stray external fields, while the absence of flexible leads prevents capacity losses.

Ideal for a Portable Receiver.

Free leaflet describing the "Polar" Coil Unit and its applications will be sent on request.

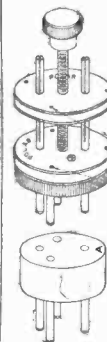
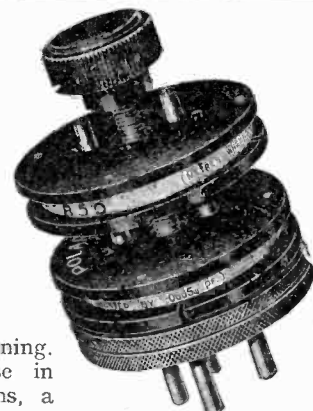

Obtainable from "Polar" Service Agents and all reputable Radio Dealers.

PRICES:

Coil Unit Complete ... 9/-
Coils, each ... 3/-
Carrier alone ... 3/-

Fits any Valve-holder. Completely interchangeable. Standard with all "Polar" Receiving Sets.

Coils are at present available to cover from 225 to 4,300 metres. All one size, 1 1/2 in. x 2 1/2 in. overall

Radio Communication Co., Ltd.,

125, Hope Street, GLASGOW.

Barnes, LONDON, S.W.13.

86, Oxford Road, MANCHESTER.



TESTED BY OURSELVES — (Concluded)

sets of fixed plates mounted opposite to each other, while a set of moving vanes may be interleaved with either set of fixed vanes, a maximum capacity of 14 micro-microfarads being obtainable on either side.

On test the insulation resistance between the moving plates and the fixed, and the one set of fixed plates and the other set was found to be infinity in each case.

This instrument is well made, pleasing in finish, and can be recommended where a balancing condenser is required.

Variable Condenser

WE have received from Messrs. Igranic Electric Co., Ltd. a sample of their Igranic-Pacnet true straight line frequency condenser.

This condenser is of the con-

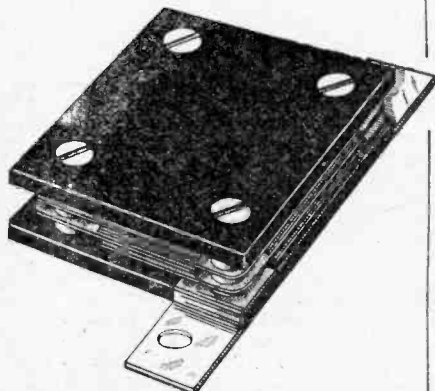

A Baltic fixed condenser with air spacing.

ventional straight-line frequency type, the plates being rather similar to the square-law type, but longer and narrower in shape. It is well constructed in brass, the moving plates being prevented from accidental warping by means of a straight bar joining them at some distance from the spindle. It is of low-loss construction, porcelain being used as the insulating medium. This component shows a high class of workmanship and is well finished. Soldering lugs are provided for making connections.

Fixed Air Condenser

A FIXED air-dielectric condenser has been received from Messrs. the Baltic Radio Co., Ltd. The plates are of

stout sheet brass mounted between two ebonite end plates 1 1/4 in. square. It was found to be of rated capacity, while losses were negligible. The two sets of plates are air spaced, no solid dielectric therefore being employed in the construction be-

tween the plates. Provision is made for soldered or screw connections as desired, two drilled lugs being incorporated as shown. This neat and compact component would appear to be especially suitable for short-wave work.

A NOVEL CHANGE-OVER CRYSTAL SET (Concluded from page 243.)

particular care over the connections to the switch, and do not keep the hot soldering bit in contact with the switch tags any longer than is necessary, otherwise you may soften the ebonite mounting.

WIRING INSTRUCTIONS

Join A to switch contact 4. Join switch contact 7 to switch contact 3, thence to fixed plates of C.

Join switch contact 8 to one side of detector; same side of detector to switch contact 1; switch contact 1 to moving plates of C; moving plates of C to socket of holder for L2.

Join switch contact 2 to switch contact 9, thence to pin of holder for L2.

Join switch contact 5 to socket of holder for L1.

Join switch contact 6 to E, E to one telephone terminal, and pin of holder for L1.

Join remaining side of detector to remaining telephone terminal.

Finally, apply the panel transfers where desired.

Testing the Set

You are now ready to try the

set, first connect the aerial and the earth wires and the telephone leads.

If your local station is of a wavelength of 360 metres upwards to about 420 metres, insert two No. 100 coils in the sockets, or a No. 100 and a No. 75, if the wavelength is lower than this. For a station at the upper limit of the broadcast band use a No. 150 and a No. 100. It does not matter

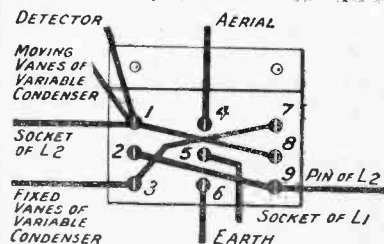

Fig. 5.—Details of the change-over switch connections.

into which socket the coils are inserted. On my aerial I can receive 5XX on any of these combinations. Then simply set the switch to the required setting, and having first adjusted the crystal detector, tune in the station and carefully readjust the detector for the best results.

A WONDERFUL PRODUCTION

The September issue of MODERN WIRELESS will be a SPECIAL AUTUMN DOUBLE NUMBER,

and will contain full constructional details of TWO REMARKABLE NEW RECEIVERS developed by our Elstree Laboratories.

A further specially attractive feature will be a striking article from the pen of

JOHN SCOTT-TAGGART, F.Inst.P., A.M.I.E.E., entitled "Greater Range and Selectivity."

See page 238 for full particulars.

Order your copy now.

Price 1s. 6d.

MODERN WIRELESS CAXTON 4-VALVE CABINET

Made for Editor of Wireless Magazine for Set "As good as money can buy" described in issue February, 1925.

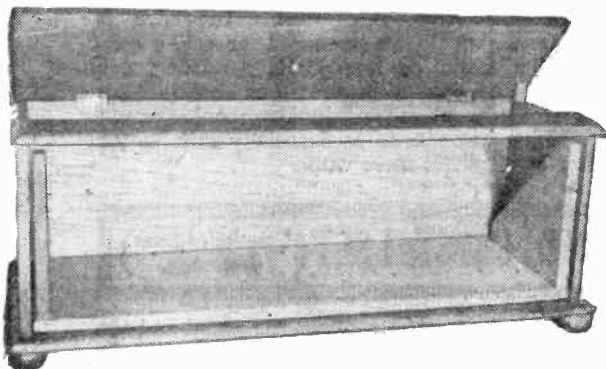

Cash with Order. Fumed Oak ... £1 5 0
or Real Mahogany polished ... £1 14 0

With detachable recess fitted Base Board to mount 21 in. by 7 in. panel to slide out of Cabinet front. Extra 10/- with two beaded front doors totally enclosing fitted panel. Cabinet overall length 22½ ins. Width 8¼ ins. Height 9 ins.

Polished with the new enamel that gives a glass hard surface that cannot be soiled or scratched.

SENT FREE.—Catalogue of standard Wireless Cabinets in various sizes and woods. Special Cabinets made to customer's orders.

PACKED AND DELIVERED FREE IN U.K.

CAXTON WOOD TURNERY CO., Market Harborough

IT IS always SAFE to depend upon **B.B.C. BATTERIES**



Prices.
No. 4w. 36 Volts. 6/6
No. 5w. 60 Volts. 11/-
No. 6w. 9 Grid Bias 2/-
No. 10w. 4½ " " 1/-

No. 4w. and 5w. 3 volt tappings.
No. 6w. and 10w. 1½ volt tappings.

PRICES INCLUDE WANDER PLUG. CARRIAGE PAID.

No. 1w. 4½ Volts. Standard Pocket Lamp Size; with patent spiral wire terminals and plug sockets to take Wander Plugs. Used Units replaced easily.

To connect in series types 1w. and 8w., insert straight Terminal in Spiral of next battery. Bend spiral and thus ensure permanent electrical connection without soldering. Note:—1 doz. = 54 volts. PRICE 7/- PER DOZ. with Plug. car. paid.

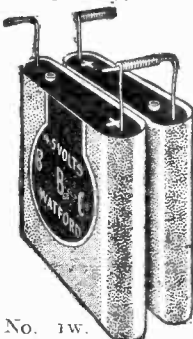

No. 1w.

No. 8w 4½ volts. Super. Capacity.

Extra Large size Unit with Patent Spiral Wire Terminal and Plug Socket to take Wander Plug. Capacity four times that of No. 1w.

Size 3½ x 1½ x 3 inches. PRICE 18/- PER DOZ. CARRIAGE PAID.



No. 8w.

To be obtained from your local dealer or direct from the

BRITISH BATTERY CO., LTD., CLARENDON RD., WATFORD, HERTS

Parrs Ad.

AUGUST, 1926

Made by the manufacturers of Glazite.

...lower H.F. resistance than any other commercial plug in coil!



TESTS carried out by the National Physical Laboratory show that the LEWCOS COIL has a lower H.F. Resistance than any other coil on the market.

Its low H.F. resistance combined with great selectivity and mechanical strength make the LEWCOS Coil the finest you can buy.

Try a LEWCOS Coil in your set—it makes all the difference. Descriptive leaflet gladly sent on request to:

The LONDON ELECTRIC WIRE COMPANY & SMITHS, Ltd. Playhouse Yard, Golden Lane, London, E.C.1.

No.	25	35	40	50	60	75	100	150	200	250	300
Price	4/6	4/6	4/6	5/-	5/6	5/6	6/9	7/6	8/6	9/-	10/-

LEWCOS Inductance COIL

JUDD

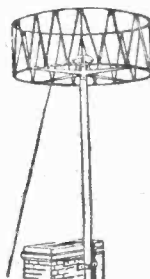

PERFEX AERIALS

Patented in Great Britain and abroad.

INCREASE SELECTIVITY, VOLUME, AND RANGE OF RECEPTION AND REDUCE INTERFERENCE AND ENABLE MAXIMUM AERIAL EFFICIENCY TO BE OBTAINED AT ANY LOCATION.

Proved by thousands of users in many different Countries. ASK THOSE WHO USE THEM.

36 in. 75/-, 20 in. 58/6, complete with down-lead. Masts—16 ft. 20/-, 22 ft. 30/-, Brackets 25/- pair.

Obtainable from all branches of THE GENERAL ELECTRIC CO., LTD., the MARCONI PHONE CO., LTD., and all good Wireless Manufacturers and Dealers.

WIRELESS APPARATUS LTD., 35, PANTON STREET, HAYMARKET, LONDON, S.W.1.



FORMO ARTHUR PEREIRA & CO. LTD.

HIGH EFFICIENCY LOW LOSS VARIO-COUPERS.

3 CIRCUIT 200-600 METRES 12/6

SEND FOR NEW CATALOGUE of COMPONENTS OF ADVANCED DESIGN

The FORMO COMPANY, Crown Works, Cricklewood, N.W. 2

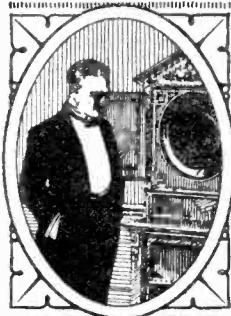

"Does All You Claim"

Readers' Opinions of "Elstree Six"



"Extraordinarily Selective"

SIR,—The "Elstree Six" appears to me to be an ideal set for the home circle on account of the ease with which it can be manipulated and stations tuned in on near wavelengths without mutual interference. It is extraordinarily selective, and even those with no knowledge of wireless should be able to work it satisfactorily in a very short time. It also opens out possibilities for the experimenter who likes to know "what is inside and why."

The wiring, at first glance, seems very complicated, but, with the assistance of the diagrams supplied, is quite simple to follow.

I enjoyed the visit to your Elstree Laboratories, and my thanks are due to Capt. Tingey and his assistants for their courtesy and readiness to supply information—a rather trying ordeal at the best of times.

To those of your readers who contemplate the building of this set I would like to give a word of advice—use only the *best* components and *British* if possible.—Yours truly, ARTHUR H. BIRD (Radio 6 A.Q.).

Nunhead, S.E. 15.

An Enthusiast's Offer

SIR,—Regarding my recent visit to your Laboratory to hear the "Elstree Six," I beg to thank you for giving me the opportunity to hear the set in operation.

The kindly manner in which the party was received, instructed and entertained by your staff was greatly appreciated. Although the visit was made at the worst time of day for receiving distant stations, the possibilities of the set were clearly demonstrated and the interest was so great that it was well after 10 p.m. before we could break away.

The volume, tone, ease of control and adjustment are wonderful, and you will easily understand the eagerness with which I ordered components the next day and commenced to build a brother set.

Difficulty in gathering the parts made rather a long job of the construction, but at last it is finished. Using coils as for Range 2, I get London at very loud strength, but can shut it out so very easily. My aerial at present is very poor, being only 7 ft. high at far end and 12 ft. at end nearest set; but in spite of this, Dublin, Hamburg and Brussels have been received. The aerial will be improved in the very near future, and I hope then to tune in all 60 stations with the same ease as is done at Elstree.

Should it be of any assistance to you, I will gladly receive by appointment any amateurs in this district wishing to see or hear the set.—Yours truly, A. MITCHELL.
Ilford.

Hundreds of enthusiastic letters have been received from readers who have heard and tried the "Elstree Six" for themselves. One who has built the receiver says "Your latest set," and states that he is able to separate Manchester from 2LO at a distance of 4 miles from the latter station. Another successful constructor is so delighted with his results that he offers to demonstrate the set to amateurs in his district.

"Complete Satisfaction"

SIR,—I feel it is my duty to extend to you my best thanks for the very pleasant and instructive evening I spent when I accepted your invitation to hear the "Elstree Six" demonstrated. I need hardly express my complete satisfaction with the results attained, as this seems to be the general opinion of all who heard the "Elstree Six"; furthermore, it does all you claim for it. I have been using my "Elstree Six" for three weeks now and the results are really remarkable. I thought my late "Special Five" was the "last word," but your latest is "it."

I am just under 4 miles from 2LO, and I separate Manchester from London, which I consider a very stiff test, and further, atmospheric permitting, these stations are worth listening to as the set possesses very fine tone. I have followed your instructions during the construction of the set with the exception of the Arperites. Instead of Arperites I have used rheotats so that different valves can be used. I find that the various types of valves suit the set, but the detector valve is very important. I hope shortly to give you a list of stations received and also photos of set. In conclusion I should like to express my appreciation of the way in which Captain Tingey demonstrated and explained the set.—Yours truly, SIDNEY JOHN ALAND.
Fulham.

"Simplicity Truly Delightful"

SIR,—My visit to Elstree was short, as I had to catch a train back to London to allow me to get to Colchester the same night.

My best thanks are due to your staff for allowing me to work the "Elstree Six" at a time when they should have been away. I found the "Elstree Six" all that you claim for it, as in the half-hour I was at the Laboratories I personally was able to tune in all the B.E.C. stations that were working, including two Relays, and this was done simply by revolving dials to given numbers marked on the chart handed to me by your representative, who confirmed these stations by the wavemeter that you have working. The simplicity of the tuning was truly delightful.

I have built the "Transatlantic Five," "Anglo Six," "Special Five," and several others, and have on several occasions worked various other special sets; but none of these, to my mind, is so simple and certain of finding the station as this your latest production.—Yours truly, ERNEST J. CLIFF.

Colchester.

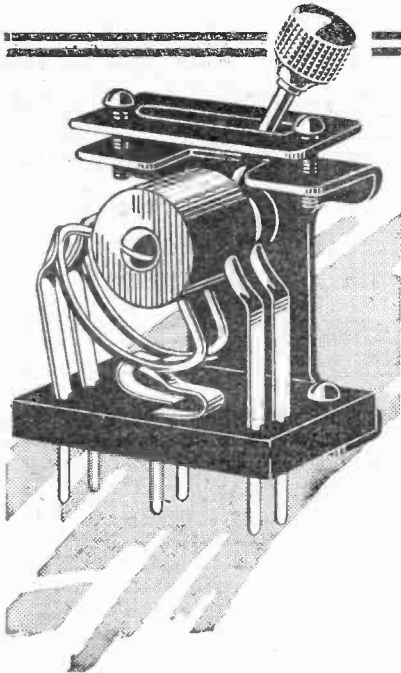

"Utility"
No - capacity
Change-over
Switch.

This reliable switch though reduced in price fully maintains the well-known "Utility" Quality. Every component part is thoroughly tested out before being assembled. "Utility" No-capacity Change-over Switches are made in six sizes changing over from one to six poles. Contacts are permanently self-cleaning and loss is reduced to the minimum.

REDUCED PRICES.

KNOB PATTERN.		LEVER PATTERN.	
120/1 3/-	120/4 5/-	147/1 3/6	147/4 6/6
120/2 3/6	130/5 6/-	147/2 4/-	147/5 8/-
130/3 4/6	130/6 7/-	147/3 5/-	147/6 8/-

Nickel Plated, 3d. each extra Nickel Plated, 6d. each extra

WILKINS & WRIGHT LTD
KENYON ST. *Utility* BIRMINGHAM

No Wireless Library Complete
without the **SIFAM** Book

of RADIO MEASURING INSTRUMENTS

Send for FREE Copy to-day.

SIFAM ELECTRICAL CO
INSTRUMENT CO.

Dept. M.W., 95, Queen Victoria St., London, E.C.4



THE NEW Pelican Two SELF-CONTAINED SET

In designing this set our first consideration was to ensure over a range of up to 25 miles, without aerial or earth, excellence of loud speaker performances under average conditions; and we have succeeded. Operates with only one control. Loud Speaker, Valves, Batteries, etc., all contained in cabinet.

PRICE COMPLETE and including royalties—£19 : 5 : 0

Prices of our 1, 3 & 5 Valve Sets

PELICAN 1 ... £10 0 0

PELICAN 3 ... £24 0 0

PELICAN 5 ... £40 0 0

Prices include royalties.

Full details upon request.

CAHILL & CO., LTD.

64, Newman Street, London, W.1

PHONE : MUSEUM 9236

Part's Ad.

SUBSCRIPTION RATES

FOR RADIO PRESS JOURNALS.

MODERN WIRELESS

15/- per annum United Kingdom.

13/6 per annum Canada and

Newfoundland.

15/- per annum Other Countries.

Lesser periods than 12 months pro rata.

THE WIRELESS CONSTRUCTOR

8/6 per annum United Kingdom.

7/6 per annum Canada and

Newfoundland.

8/6 per annum Other Countries.

Lesser periods than 12 months pro rata.

WIRELESS

(Incorporating Wireless Weekly)

13/- per annum United Kingdom.

13/- per annum Canada and

Newfoundland.

13/- per annum Other Countries.

Lesser periods than 12 months pro rata.

THE WIRELESS DEALER

(Available to the Trade only)

7/6 per annum (10/- abroad).

N.B.—Business letter heading or trade card must be sent with subscription.

RADIO PRESS LIMITED,

Bush House, Strand, London, W.C.2.

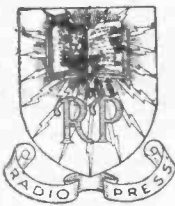

100% EFFICIENT H.T. BATTERY.

CONSTRUCTOR IDEAL.

As tested by 'Modern Wireless,' April, 1924. Why buy inefficient tiny sealed-in batteries? I offer Terminalled Giant Unit Dry Cells 1 1/2 volts of 300 p.c. bigger capacity. Compare photo 60 volt in leatherette case, 14/6. In polished oak case as tested 19/6. Carriage 1/9. Spare cells 4/- doz. plus carriage. Every cell replaceable. Sample cell, 6d. Lists free. Numerous repeat orders. Prompt delivery. Direct only from maker, saving 50%.

C. A. FINCHETT (Dept. M.), Old Armoury, Oswestry.

"TURRET" MASTS

COLUMBIAN TIMBER MASTS BY NAVAL EXPERTS

20 ft. Turret Junr. £1 19 6	2 ft. Telescopic £4 4 0
27 ft. Turret Two 2 4 6	45 ft. Telescopic 4 10 6
40 ft. Turret Three 2 18 9	58 ft. Sajer 6 19 6

SIMPSON & BLYTHE, 8-9, Sherwood St., Piccadilly, W.
Phone: Gerrard 2650.

This one has two windings !

Two windings, one of a resistance of 6 ohms and a continuation of this on to a 30-ohm strip winding. Made specially to meet demand for a rheostat covering needs of both bright and dull emitter valves. Resistance wire wound on hard fibre strip under great tension and immune

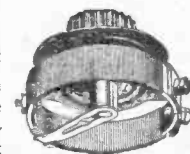

The "PEERLESS" DUAL RHEOSTAT

3/9

from damage. One-hole fixing, terminals conveniently placed, Contact arm has smooth silky action. All metal parts nickel plated.

Complete with ebonite combined Knob and Dial.

From Dealers or Direct Trade Terms on request.

THE BEDFORD ELECTRICAL & RADIO CO., LTD.,
22, Campbell Road, Bedford.

THE "SCREENED-COIL THREE"—(Concluded from page 229)

The H.F. Transformer

The high-frequency transformer is rather more complicated to construct, and requires a certain amount of care. The secondary former is 2 in. in diameter, as with the aerial coil, the primary, neutralising and reaction windings being carried on a smaller former $1\frac{1}{8}$ in. in diameter placed inside the secondary.

The secondary winding comprises 90 turns of 30 D.S.C. spaced 40 turns to the inch as with the aerial coil. The construction of the primary and neutralising winding is a matter which requires greatest care. The neutralising winding is wound on the former first, and consists of 20 turns of 30 D.S.C. wire wound in a single layer, and placed in the centre of the former so that it comes in the centre of the secondary winding.

The Primary Winding

Over this winding a layer of Empire tape or suitable insulating tape is placed, and a further 20 turns of D.S.C. wire are wound in the same direction. This latter winding is the primary winding of the transformer and is placed on the outside in order to bring it as close as possible to the secondary. The end of the first (neutralising) winding is taken to the beginning of the second (primary) winding. The two windings, therefore, form one continuous winding with a tapping in the centre, but the two halves of the winding are wound one on top of the other.

An Important Point

It is essential to observe that the two windings from start to finish shall be wound in the same direction, and to take particular care that the end of the first winding is connected to the beginning of the second. It is possible to obtain apparent neutralisation if these windings are put on in the wrong direction relative to each other, but the selectivity and signal strength suffer considerably if this mistake is made.

The Reaction Winding

The inside former also contains the reaction winding, which consists of 25 turns of 30 D.S.C. wire. All the four windings just described are wound in the same direction, and the reaction winding is arranged

to come towards the bottom of the primary former. The connection on this reaction winding again requires a little consideration. The beginning of winding goes to terminal No. 6, as is indicated on the diagram in Fig. 3. The end of this winding is joined to the beginning of the secondary winding, which is also connected to terminal No. 2. The end of the secondary winding goes to terminal No. 1, while the connections to the primary and neutralising windings are as indicated in the figure.

Valves to Use

The valves to use with this set are not critical. A high impedance valve should be used for the first stage in order that adequate selectivity may be obtained. For the second valve any suitable rectifying valve may be employed, and there is very little to choose between the various makes. A suitable power valve should be employed for the last stage.

H.T. Voltages

The high-tension voltage depends very largely on the valves in use. The high-frequency valves both have the same value of high-tension, while the rectifier valve has a separate tapping.

In my case I used 120 volts on the H.F. and L.F. valves and 60 on the rectifier, but these values are not at all critical and should be decided in conformity with the actual maker's recommendations.

Test Report

The receiver has been tested at Elstree and the stations given in the accompanying list were obtained. The selectivity was good, it being possible to obtain Cardiff and Manchester when London was working. Manchester was free of interference, but Cardiff was interfered with slightly by London.

A test was also made at a distance of $1\frac{1}{2}$ miles from 2LO with a view to finding what selectivity was possible at such close range. The aerial employed was a small one owing to confined space; but it was found possible to obtain good signals from Bournemouth when London was working, while Manchester could be heard quite comfortably with a background of London.

Anti-microphonic valve holders must have these five features

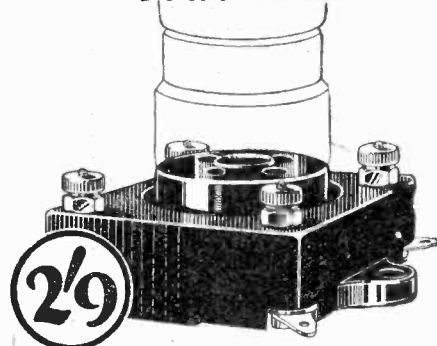

To MOUNT a valve on springs is not enough. It must be "floated"—cushioned against vibration in every direction. Before you buy an anti-microphonic valve holder make sure that it has the following features:

- (1) The socket must be perfectly free to float in every direction—parallel, lateral, and vertical. In addition the springs must be of sufficient strength to "float" the heaviest valve.
- (2) There must be no clamped or riveted joints between soldering tag and valve socket. In the *Benjamin Clearer Tone Valve Holder* it is one piece of solid metal from tag to socket.
- (3) There must be a straight through hole to assist any cleaning and prevent accumulation of dust.
- (4) Spring movement must be restricted by suitable stops to protect the springs when inserting or removing a tight valve.
- (5) The holder must be so designed that when the valve legs are pushed home they cannot possibly touch the base-board.

The extraordinary success of the *Benjamin Clearer Tone Valve Holder* lies in the fact that it possesses every one of these essential features. In addition, terminals as well as soldering tags are provided to allow new circuits to be tried out easily.

BRITISH **BENJAMIN** MADE
CLEARER TONE VALVE HOLDER
(ANTI-MICROPHONIC)

Patent Nos. 222086—1923
250431—1925
Regd. Design No. 714847

From your Dealer or direct from
THE BENJAMIN ELECTRIC Ltd.,
Brantwood Works, Tariff Road
Tottenham, N. 17

Index to Advertisers

	PAGE
American Hard Rubber Co. (Britain) Ltd.	275
Ashley Wireless Telephone Co.	277
Beard and Fitch	281
Bedford Electrical Co.	286
Benjamin Electric, Ltd.	287
Bird (Sydney S.)	259
A. Black	276
Bowyer-Lowe Co., Ltd.	193
British Battery Co.	284
Brown Brothers, Ltd.	259
Brown (S. G.), Ltd.	259
Burne-Jones and Co., Ltd.	282
Cahill and Co., Ltd.	286
Carrington Mfg. Co., Ltd.	281
Caxton Wood Turnery Co.	284
Cleartron Radio, Ltd.	194
Cossor (A. C.), Ltd.	247
Day (Will), Ltd.	277
Dubilier Condenser Co. (1925), Ltd.	257
Electron Co., Ltd.	257
Fada Radio, Ltd.	281
Ferranti, Ltd.	282
Finchett (C. A.)	286
Finston Mfg. Co., Ltd.	280

	PAGE
Förmo Co.	284
Garnett, Whiteley and Co., Ltd.	263, 275
Hamley Bros., Ltd.	280
Igranic Electric Co., Ltd.	255
Jackson Bros.	263
Lissen, Ltd.	267
London Electric Wire Co.	284
London Radio Supply Co.	288
Claude Lyons	277
M. and A. W.	280
M.A.P. Co.	276
Mullard Wireless Service Co., Ltd.	Cover ii
Oldham Accumulators	251
Penton Engineering Co.	276

	PAGE
Peto-Scott Co., Ltd.	279, 288
Picketts	276
Portable Utilities Co., Ltd.	270
Radio Communication Co., Ltd.	282
Radio Instruments, Ltd.	Cover iv
Radions, Ltd.	288
Redferns Rubber Works, Ltd.	248
Rothermel Radio Corporation of Gt. Britain, Ltd.	275
Sifan Electrical Instrument Co.	286
C. Simmonds	288
Simpson and Blythe	286
Valco, Ltd.	276
Varley Magnet Co.	276
Wilkins and Wright	286
Wireless Apparatus, Ltd.	284

EASY PAYMENTS We supply by easy payments, components, accessories and sets. Any make. 10% down, balance spread over one year. Send list of requirements to **LONDON RADIO SUPPLY CO., 11, Oat Lane, London E.C.2. Phone, City 1977.**

WIRELESS CABINETS
Of Every Description.
C. SIMMONDS, 13, Greek Street, W.1.
Trade Enquiries Invited.

2-Volt Power Valve 12/6
This is a REAL power valve—British Made—Radion Guaranteed—and far less money than other leading makes. From untied dealers or direct.
RADION Reliable Valves
RADIONS Ltd. — Bolling-on-Ne. Macclesfield, CHESHIRE

A free Insurance Policy with every "Elstree Six"!

IN buying a large receiver, such as the wonderful "Elstree Six" Receiver, you want positive assurance of complete satisfaction. If you buy your instrument from us, you are not only certain of excellent results, but you will receive in addition a further safeguard. With every complete "Elstree Six" Receiver we give a Free Insurance Policy against Fire, Burglary, and Lightning for one year. Receiver, in handsome, well-finished Cabinet (less valves and batteries). **£30** Marconi Royalties £3 15 0 extra.

Complete Kits of Parts

If, however, you want to build the set yourself, we can supply the complete Kit of Components (to Author's specification) **£20**

C. With every Complete Kit of Components a Marconi Royalty of 12s. 6d. per valve holder is payable and must be remitted with order.

Peto-Scott Neutralising Condenser

used in the "Elstree Six."

The Peto-Scott Neutralising Condenser used in the "Elstree Six" is an efficient component embodying four fixed and three moving vanes, which can be automatically locked when the correct neutralising position is obtained. Wide spacing of the plates ensures non shorting. Supplied with extra long handle to eliminate capacity.

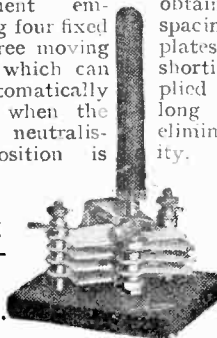

Board Mounting as illustrated, 5s. 0d.

Panel Mounting Type 6s. 3d.

The Peto-Scott Cabinet for the "Elstree Six."

The De Luxe Cabinet which we supply for the "Elstree Six" will harmonise with the furniture and enhance the appearance of any room. The solid mahogany, of which the Cabinet is constructed throughout, has a fine piano-finish. The three massive hinges, solid brass lid supports, 5-ply non-warping base-board and wooden end-pieces complete an excellent "house" for your set. Price (carriage paid), **£4 4 0.** Packing case 10s. extra, refunded on return.

If required, we supply a best quality ebonite panel, cut to fit, drilled, tapped and engraved. Price **£1 7 6.**

The "Keystone" Super-Heterodyne Book giving full constructional details (with blue prints) and other diagrams. Post free **1s. 3d.**

Catalogue of all Components, 48 pages, post free **3d.**

PETO-SCOTT Co., Ltd., 77, City Rd., E.C.1. Branches at 62, High Holborn, W.C.1, Walthamstow, Plymouth & Liverpool

P.S. 5186

FREE BLUEPRINT SERVICE COUPON

Modern Wireless Vol. VI. No. 3. August, 1926

This coupon entitles the reader to one blueprint of any set described in the above issue, and must accompany each postal application.

COUPON.

Questions & Answers.

In future this coupon must be accompanied by a P.O. for 2/6 for each question and a stamped addressed envelope.

"MODERN WIRELESS" AUGUST, 1926.



Keeps you informed of every latest product

AMONG the permanent features of THE WIRELESS DEALER, that entitled "What the Manufacturers are Doing" should be carefully read by every retailer—particularly upon the approach of the Exhibitions.

Under this heading the Editor gathers every interesting and salient point characterising new products. The Test Reports from the Laboratories at Elstree upon manufacturers' apparatus appear in this feature, the whole containing many essential selling points which will prove invaluable to the enterprising dealer.

By reading this article every month you are kept posted—no new line which you should have in stock will escape your notice. A subscription to THE WIRELESS DEALER is an insurance against buying obsolete apparatus. Send for a specimen copy to-day.

SELECTION FROM CONTENTS

Speed up the High-Power Stations!

"The Wireless Dealer" Service and Testing Unit
By Percy W. Harris, M.I.R.E.

There is No Slump!
By A. Wragge

Plain Words on Trade Conditions
By Leon A. Sharland

New Components for the Coming Season
By J. H. Reuner, B.Sc. (Hons.), A.C.G.I.,
D.I.C., A.M.I.E.E.

SUBSCRIPTION RATES: 7/6 per annum (abroad 10/-). Available to the Trade only. Trade card or business heading should accompany every subscription to the SALES MANAGER, Radio Press, Ltd., Bush House, Strand, London, W.C.2

The Wireless Dealer
AND MANUFACTURER

4 Steps to Better Radio

R.I. Components will do more than any others to help you with your set building. They not only make the actual construction easier, but they go a long way towards ensuring the most satisfactory results.

There is a reliable R.I. Product for each successive stage of your set, ready to give perfect results in the capacity in which it can be used.

Let us commence with **The R.I. Duostat**, a filament rheostat unsurpassed for silence and surety of control. Its special construction allows it to be used for either bright or dull emitter valves, a black scale showing the correct position for each type. It is certainly worth your while to pay the little more for this rheostat and take one of the first steps towards better radio.

PRICE 7/6

The R.I. Reactive Anode Unit. Built to tune those distant signals to good strength. Has five tappings covering all wavelengths from 200-4,000 metres, three of them serving to cover the broadcast band and giving excellent adjustment. Owing to the special winding the impedance of each tapping keeps the reactance values approximately uniform for all wavelengths.

PRICE 25/-

The R.I. Retroactive Tuner provides more efficient tuning over the range of wavelengths from 175 to 4,000 metres and costs less than a set of coils with coil-holder to cover the same range. It is wound on the single layer method proved by eminent technicians to be more efficient than the multi-layer method.

PRICE 39/6

The R.I. Permanent Mineral Detector. Here we have a crystal detector absolutely permanent and unaffected by vibration. No catwhisker is employed, a spring plunger maintains the correct pressure on the crystal, which is sensitive throughout its area, making it unnecessary to search for special sensitive spots.

Manufactured in two different forms. Standard pattern, with supporting clips for mounting either above or below the panel, and one-hole fixing pattern with detachable ebonite cover which protects the adjusting knob when in position.

PRICES:

Standard Pattern .. 6/-

One-hole fixing type .. 7/6

Write for the R.I. Blue and Gold Catalogue.

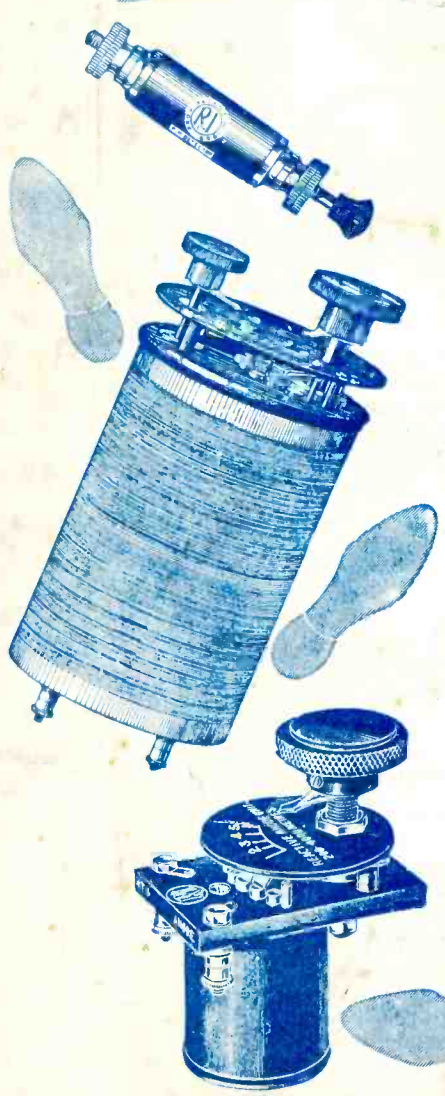

THE MARK OF BETTER RADIO

Advt. R.I. Ltd., 12, Hyde Street, New Oxford Street, London, W.C.1.

P.C. 35